

HCA65R210F

650V N-Channel Super Junction MOSFET

Features

- Very Low FOM ($R_{DS(on)} \times Q_g$)
- Extremely low switching loss
- Excellent stability and uniformity
- 100% Avalanche Tested
- Built-in ESD Diode

Application

- Switch Mode Power Supply (SMPS)
- Uninterruptible Power Supply (UPS)
- Power Factor Correction (PFC)
- AC to DC Converters
- Telecom, Solar

Key Parameters

| Parameter | Value | Unit |
|------------------------|-------|----------|
| $BV_{DSS} @ T_{j,max}$ | 700 | V |
| I_D | 16.8 | A |
| $R_{DS(on), max}$ | 0.21 | Ω |
| Q_g, Typ | 40 | nC |

Package & Internal Circuit

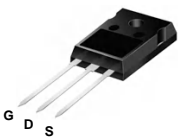
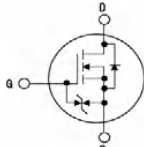
| TO-247 | SYMBOL |
|---|---|
|  |  |

Absolute Maximum Ratings $T_C=25^\circ\text{C}$ unless otherwise specified

| Symbol | Parameter | Value | Unit |
|----------------|---|-------------|------------------|
| V_{DSS} | Drain-Source Voltage | 650 | V |
| V_{GS} | Gate-Source Voltage | ± 20 | V |
| I_D | Drain Current - Continuous ($T_C = 25^\circ\text{C}$) | 16.8 | A |
| | Drain Current - Continuous ($T_C = 100^\circ\text{C}$) | 10.6 | A |
| $I_{DM}^{1)}$ | Drain Current - Pulsed | 50 | A |
| $E_{AS}^{2)}$ | Single Pulsed Avalanche Energy | 250 | mJ |
| I_{AR} | Avalanche Current | 2.4 | A |
| dv/dt | MOSFET dv/dt ruggedness, $V_{DS}=0\dots 400\text{V}$ | 50 | V/ns |
| dv/dt | Reverse diode dv/dt, $V_{DS}=0\dots 400\text{V}$, $I_{DS}\leq I_D$ | 15 | V/ns |
| P_D | Power Dissipation ($T_C = 25^\circ\text{C}$) | 130 | W |
| $V_{ESD(G-S)}$ | Gate source ESD(HBM-C=100pF, R=1.5K Ω) | 2000 | V |
| T_J, T_{STG} | Operating and Storage Temperature Range | -55 to +150 | $^\circ\text{C}$ |

Thermal Resistance Characteristics

| Symbol | Parameter | Value | Unit |
|-----------------|---|-------|--------------------|
| $R_{\theta JC}$ | Thermal Resistance, Junction-to-Case, Max. | 0.96 | $^\circ\text{C/W}$ |
| $R_{\theta JA}$ | Thermal Resistance, Junction-to-Ambient, Max. | 62.5 | $^\circ\text{C/W}$ |

Electrical Characteristics $T_J=25^\circ\text{C}$ unless otherwise specified

| Symbol | Parameter | Test Conditions | Min | Typ | Max | Unit |
|---|---|---|-----|-------|---------|---------------|
| On Characteristics | | | | | | |
| V_{GS} | Gate Threshold Voltage | $V_{DS} = V_{GS}, I_D = 670 \mu\text{A}$ | 2.5 | - | 5.0 | V |
| $R_{DS(ON)}$ | Static Drain-Source On-Resistance | $V_{GS} = 10 \text{ V}, I_D = 6.2 \text{ A}$ | - | 0.185 | 0.21 | Ω |
| Off Characteristics | | | | | | |
| BV_{DSS} | Drain-Source Breakdown Voltage | $V_{GS} = 0 \text{ V}, I_D = 1 \text{ mA}$ | 650 | - | - | V |
| I_{DSS} | Zero Gate Voltage Drain Current | $V_{DS} = 650 \text{ V}, V_{GS} = 0$ | - | - | 1 | μA |
| | | $V_{DS} = 650 \text{ V}, T_C = 150^\circ\text{C}$ | - | 220 | - | μA |
| I_{GSS} | Gate-Body Leakage Current | $V_{GS} = \pm 20 \text{ V}, V_{DS} = 0 \text{ V}$ | - | - | ± 1 | μA |
| Dynamic Characteristics | | | | | | |
| C_{iss} | Input Capacitance | $V_{DS} = 400 \text{ V}, V_{GS} = 0 \text{ V},$ $f = 1.0 \text{ MHz}$ | - | 1750 | - | pF |
| C_{oss} | Output Capacitance | | - | 39 | - | pF |
| C_{rss} | Reverse Transfer Capacitance | | - | 3.4 | - | pF |
| Switching Characteristics | | | | | | |
| $t_{d(on)}$ | Turn-On Time | $V_{DS} = 325 \text{ V}, I_D = 8.7 \text{ A},$ $R_G = 25 \Omega$ (Note 3,4) | - | 39 | - | ns |
| t_r | Turn-On Rise Time | | - | 21 | - | ns |
| $t_{d(off)}$ | Turn-Off Delay Time | | - | 171 | - | ns |
| t_f | Turn-Off Fall Time | | - | 18 | - | ns |
| $Q_{g()}$ | Total Gate Charge | $V_{DS} = 520 \text{ V}, I_D = 8.7 \text{ A},$ $V_{GS} = 10 \text{ V}$ (Note 3,4) | - | 40 | - | nC |
| Q_{gs} | Gate-Source Charge | | - | 8 | - | nC |
| Q_{gd} | Gate-Drain Charge | | - | 12 | - | nC |
| Drain-Source Diode Characteristics and Maximum Ratings | | | | | | |
| I_S | Maximum Continuous Drain-Source Diode Forward Current | | - | - | 16.8 | A |
| I_{SM} | Maximum Pulsed Drain-Source Diode Forward Current | | - | - | 50 | A |
| V_{SD} | Drain-Source Diode Forward Voltage | $V_{GS} = 0 \text{ V}, I_S = 8.7 \text{ A}$ | - | - | 1.3 | V |
| t_{rr} | Reverse Recovery Time | $V_R = 400 \text{ V}, I_F = 8.7 \text{ A}$ $di_F/dt = 100 \text{ A}/\mu\text{s}$ | - | 149 | - | ns |
| Q_{rr} | Reverse Recovery Charge | | - | 0.92 | - | μC |

Notes :

1. Repetitive Rating : Pulse width limited by maximum junction temperature
2. $I_{AS}=2.4\text{A}$ $V_{DD}=50\text{V}$, $R_G=25\Omega$, Starting $T_J=25^\circ\text{C}$
3. Pulse Test : Pulse Width $\leq 300\mu\text{s}$, Duty Cycle $\leq 2\%$
4. Essentially Independent of Operating Temperature

Typical Characteristics

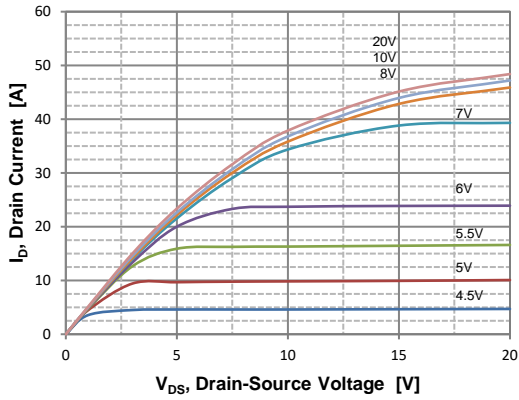

Figure 1. On Region Characteristics

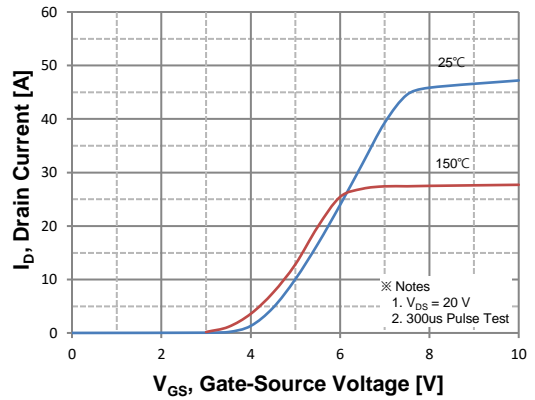

Figure 2. Transfer Characteristics

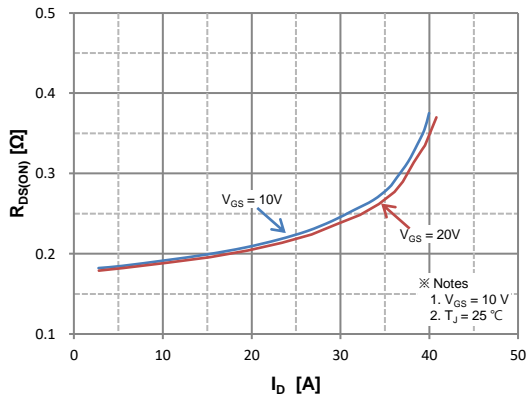

Figure 3. On Resistance Variation vs Drain Current and Gate Voltage

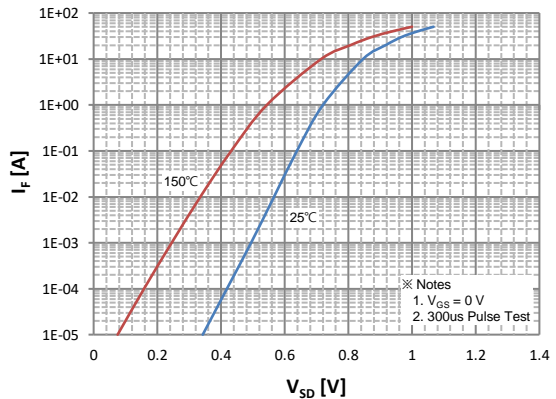

Figure 4. Body Diode Forward Voltage Variation with Source Current and Temperature

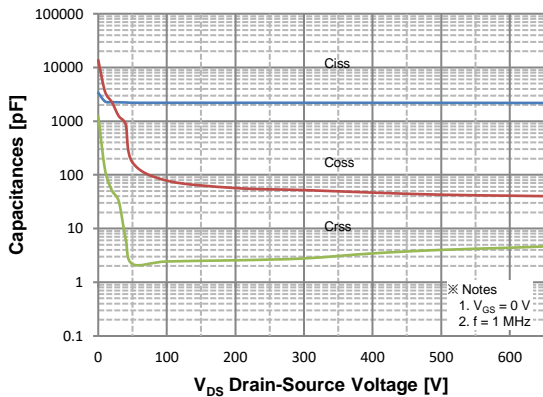

Figure 5. Capacitance Characteristics

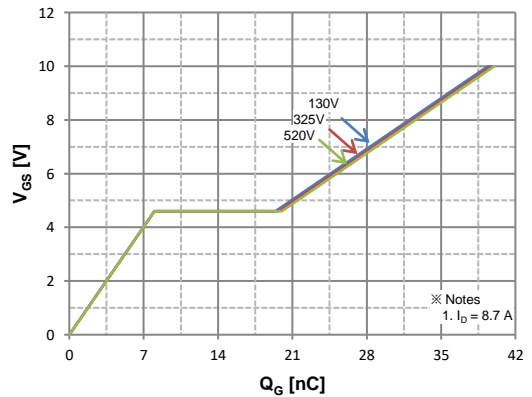

Figure 6. Gate Charge Characteristics

Typical Characteristics

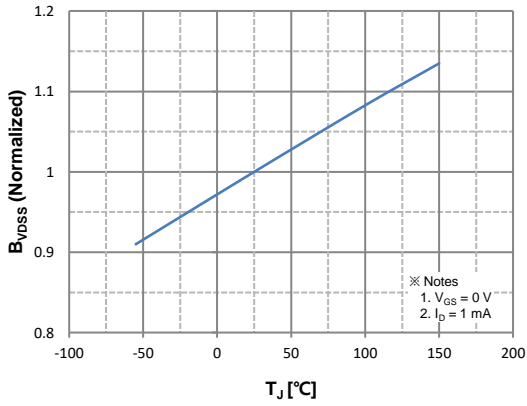

Figure 7. Breakdown Voltage Variation vs. Temperature

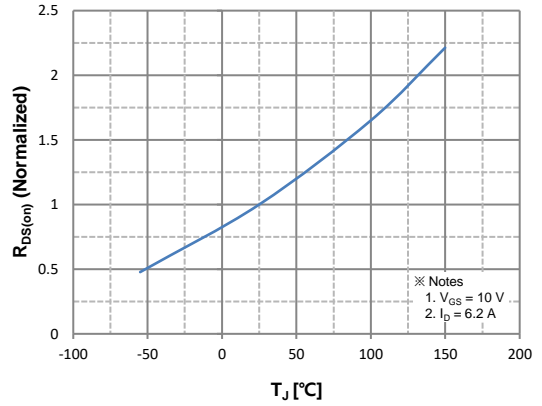

Figure 8. On-Resistance Variation vs. Temperature

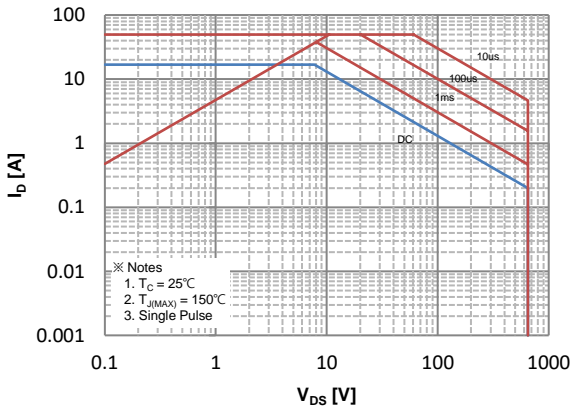

Figure 9. Maximum Safe Operating Area

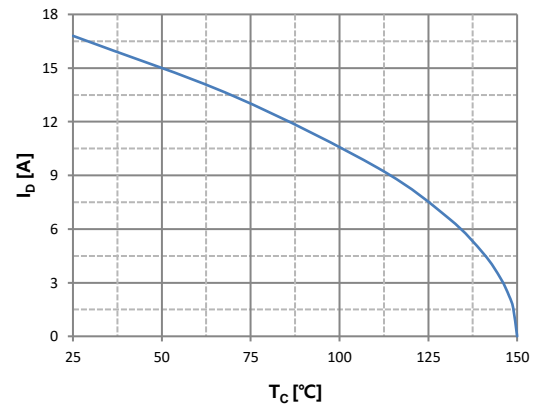

Figure 10. Maximum Drain Current vs. Case Temperature

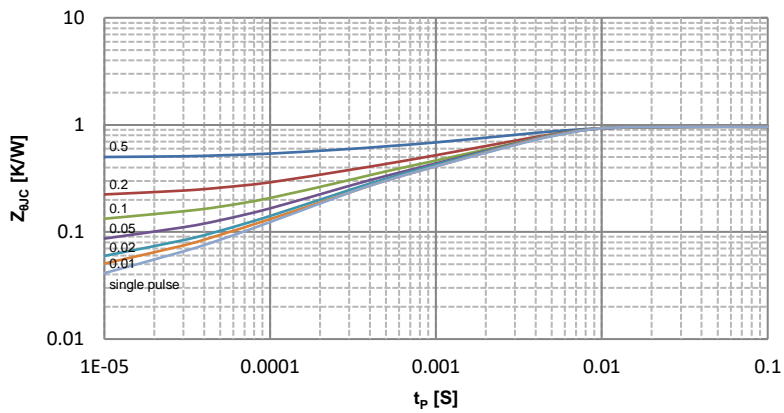

Figure 11. Transient Thermal Response Curve

Fig 12. Gate Charge Test Circuit & Waveform

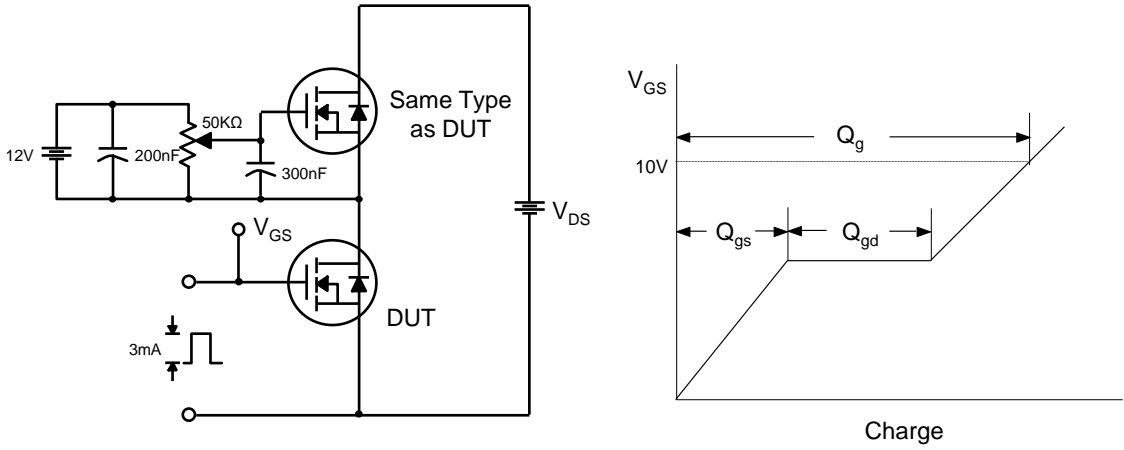

Fig 13. Resistive Switching Test Circuit & Waveforms

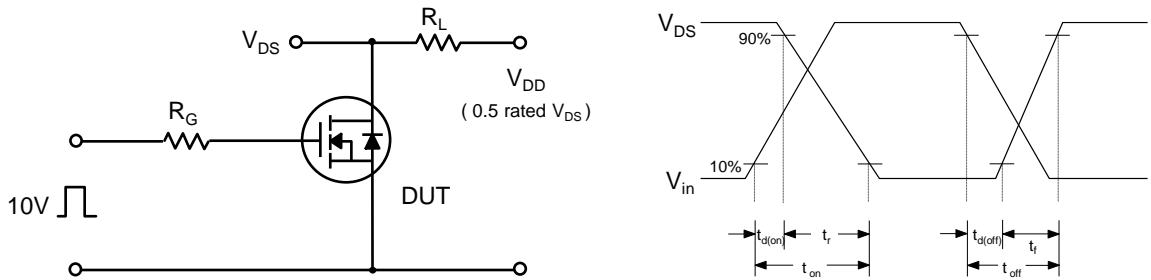

Fig 14. Unclamped Inductive Switching Test Circuit & Waveforms

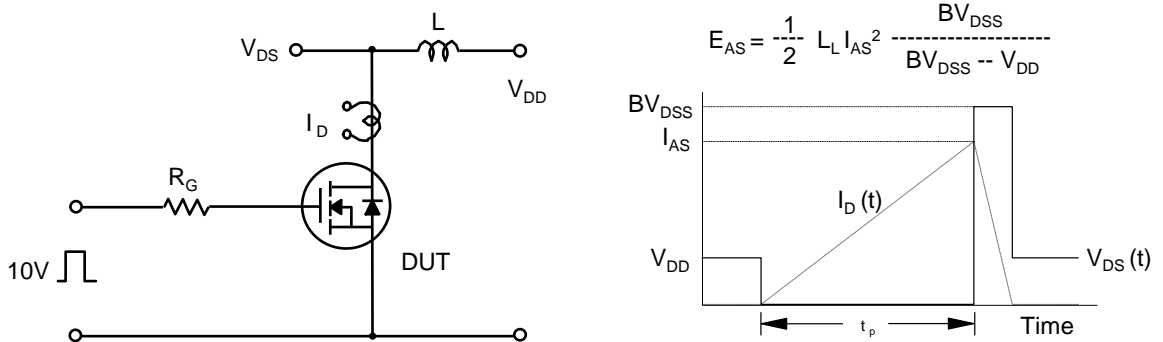
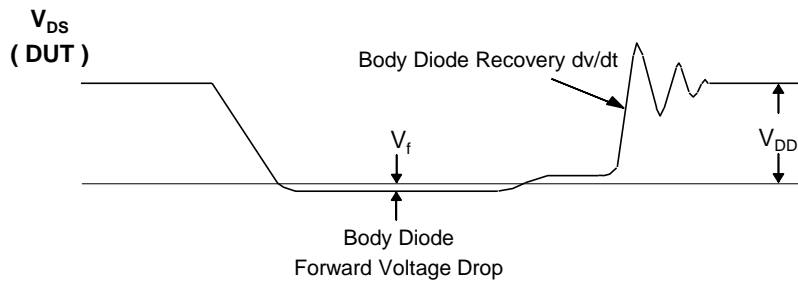
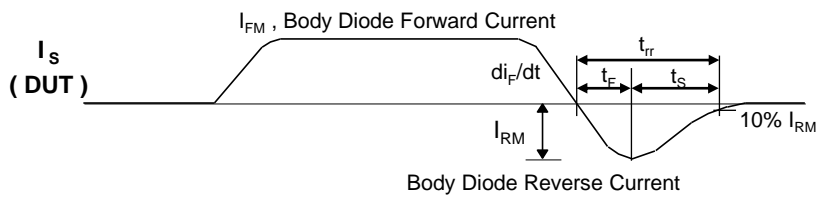
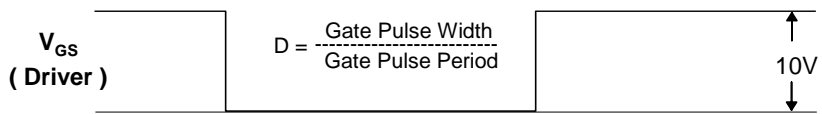
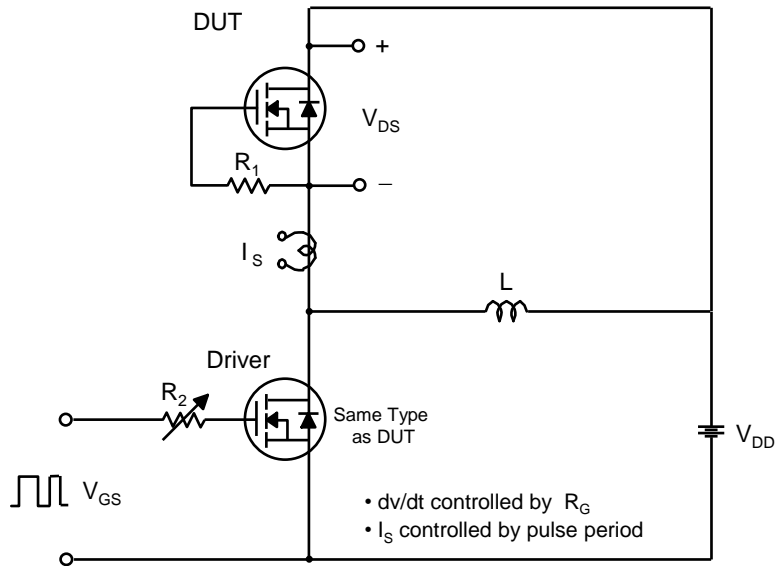

Fig 15. Peak Diode Recovery dv/dt Test Circuit & Waveforms



Package Dimension

TO-247

