

HCA60R150

600V N-Channel Super Junction MOSFET

Features

- Very Low FOM ($R_{DS(on)} \times Q_g$)
- Extremely low switching loss
- Excellent stability and uniformity
- 100% Avalanche Tested
- Built-in ESD Diode

Application

- Switch Mode Power Supply (SMPS)
- Uninterruptible Power Supply (UPS)
- Power Factor Correction (PFC)
- AC to DC Converters
- Telecom, Solar

Key Parameters

Parameter	Value	Unit
$BV_{DSS} @ T_{j,max}$	650	V
I_D	21.4	A
$R_{DS(on), max}$	0.15	Ω
Q_g, Typ	50	nC

Package & Internal Circuit

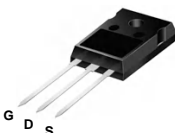
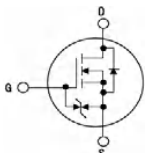
TO-247	SYMBOL
	

Absolute Maximum Ratings $T_C=25^\circ\text{C}$ unless otherwise specified

Symbol	Parameter	Value	Unit
V_{DSS}	Drain-Source Voltage	600	V
V_{GS}	Gate-Source Voltage	± 20	V
I_D	Drain Current - Continuous ($T_C = 25^\circ\text{C}$)	21.4	A
	Drain Current - Continuous ($T_C = 100^\circ\text{C}$)	13.5	A
$I_{DM}^{1)}$	Drain Current - Pulsed	64	A
$E_{AS}^{2)}$	Single Pulsed Avalanche Energy	330	mJ
I_{AR}	Avalanche Current	2.75	A
dv/dt	MOSFET dv/dt ruggedness, $V_{DS}=0\dots 400\text{V}$	50	V/ns
dv/dt	Reverse diode dv/dt, $V_{DS}=0\dots 400\text{V}$, $I_{DS} \leq I_D$	15	V/ns
P_D	Power Dissipation ($T_C = 25^\circ\text{C}$)	151	W
$V_{ESD(G-S)}$	Gate source ESD(HBM-C=100pF, R=1.5K Ω)	2000	V
T_J, T_{STG}	Operating and Storage Temperature Range	-55 to +150	$^\circ\text{C}$

Thermal Resistance Characteristics

Symbol	Parameter	Value	Unit
$R_{\theta JC}$	Thermal Resistance, Junction-to-Case, Max.	0.83	$^\circ\text{C/W}$
$R_{\theta JA}$	Thermal Resistance, Junction-to-Ambient, Max.	62.5	$^\circ\text{C/W}$

Electrical Characteristics $T_J=25\text{ }^\circ\text{C}$ unless otherwise specified

Symbol	Parameter	Test Conditions	Min	Typ	Max	Unit
On Characteristics						
V_{GS}	Gate Threshold Voltage	$V_{DS} = V_{GS}, I_D = 850\ \mu\text{A}$	2.0	-	4.0	V
$R_{DS(ON)}$	Static Drain-Source On-Resistance	$V_{GS} = 10\ \text{V}, I_D = 8.7\ \text{A}$	-	0.13	0.15	Ω
Off Characteristics						
BV_{DSS}	Drain-Source Breakdown Voltage	$V_{GS} = 0\ \text{V}, I_D = 1\ \text{mA}$	600	-	-	V
I_{DSS}	Zero Gate Voltage Drain Current	$V_{DS} = 600\ \text{V}, V_{GS} = 0$	-	-	1	μA
		$V_{DS} = 600\ \text{V}, T_C = 150\text{ }^\circ\text{C}$	-	-	100	μA
I_{GSS}	Gate-Body Leakage Current	$V_{GS} = \pm 20\ \text{V}, V_{DS} = 0\ \text{V}$	-	-	± 1	μA
Dynamic Characteristics						
C_{iss}	Input Capacitance	$V_{DS} = 400\ \text{V}, V_{GS} = 0\ \text{V},$ $f = 1.0\ \text{MHz}$	-	2180	-	pF
C_{oss}	Output Capacitance		-	50	-	pF
C_{riss}	Reverse Transfer Capacitance		-	2.6	-	pF
Switching Characteristics						
$t_{d(on)}$	Turn-On Time	$V_{DS} = 300\ \text{V}, I_D = 11\ \text{A},$ $R_G = 25\ \Omega$ (Note 3,4)	-	45	-	ns
t_r	Turn-On Rise Time		-	23	-	ns
$t_{d(off)}$	Turn-Off Delay Time		-	201	-	ns
t_f	Turn-Off Fall Time		-	18	-	ns
Q_{gt}	Total Gate Charge	$V_{DS} = 480\ \text{V}, I_D = 11\ \text{A},$ $V_{GS} = 10\ \text{V}$ (Note 3,4)	-	50	-	nC
Q_{gs}	Gate-Source Charge		-	10	-	nC
Q_{gd}	Gate-Drain Charge		-	14	-	nC
Drain-Source Diode Characteristics and Maximum Ratings						
I_S	Maximum Continuous Drain-Source Diode Forward Current		-	-	21.4	A
I_{SM}	Maximum Pulsed Drain-Source Diode Forward Current		-	-	64	A
V_{SD}	Drain-Source Diode Forward Voltage	$V_{GS} = 0\ \text{V}, I_S = 11\ \text{A}$	-	-	1.3	V
t_{rr}	Reverse Recovery Time	$V_R = 400\ \text{V}, I_F = 11\ \text{A}$ $di_F/dt = 100\ \text{A}/\mu\text{s}$	-	370	-	ns
Q_{rr}	Reverse Recovery Charge		-	5.0	-	μC

Notes :

1. Repetitive Rating : Pulse width limited by maximum junction temperature
2. $I_{AS}=2.75\text{A}$ $V_{DD}=50\text{V}$, $R_G=25\Omega$, Starting $T_J=25\text{ }^\circ\text{C}$
3. Pulse Test : Pulse Width $\leq 300\mu\text{s}$, Duty Cycle $\leq 2\%$
4. Essentially Independent of Operating Temperature

Typical Characteristics

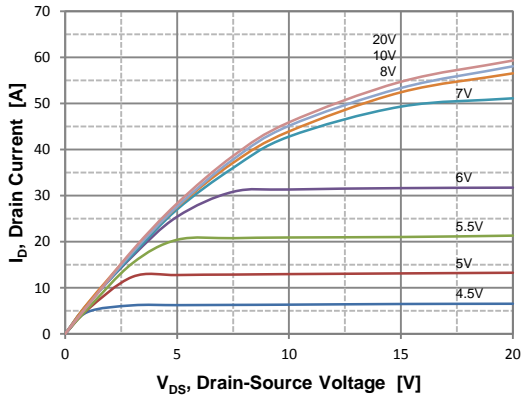

Figure 1. On Region Characteristics

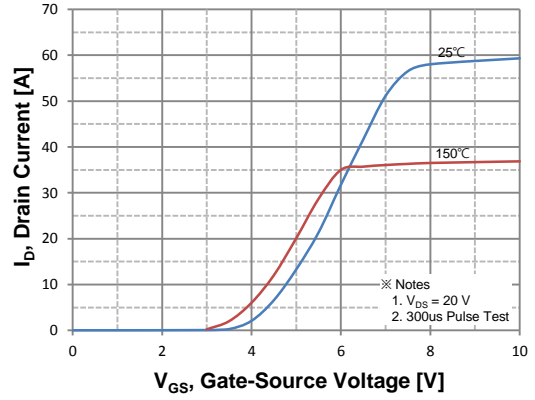

Figure 2. Transfer Characteristics

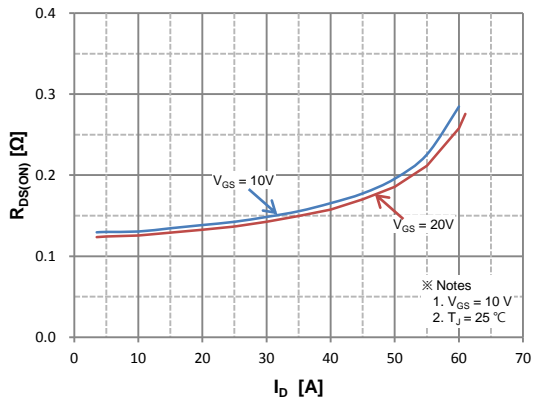

Figure 3. On Resistance Variation vs Drain Current and Gate Voltage

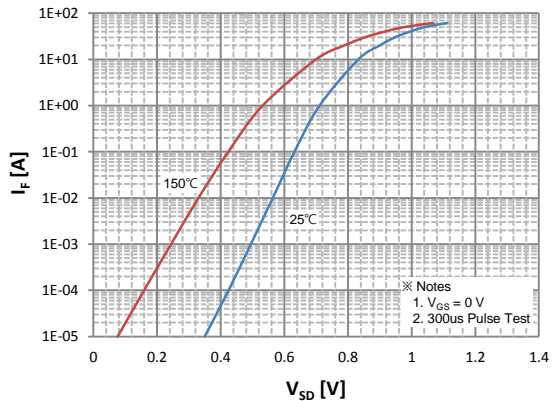

Figure 4. Body Diode Forward Voltage Variation with Source Current and Temperature

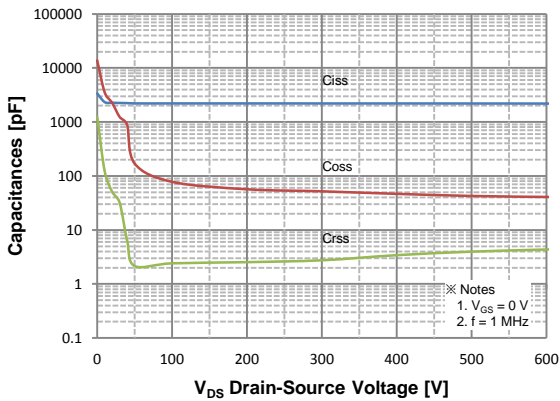

Figure 5. Capacitance Characteristics

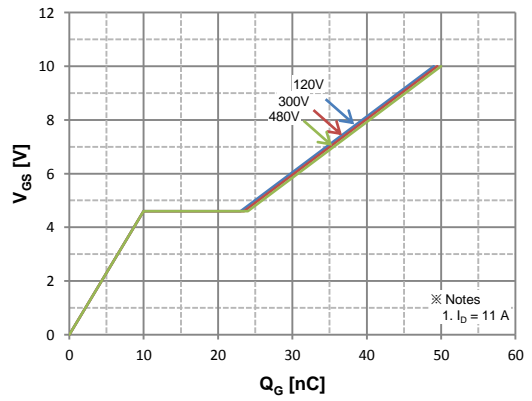

Figure 6. Gate Charge Characteristics

Typical Characteristics



Figure 7. Breakdown Voltage Variation vs. Temperature

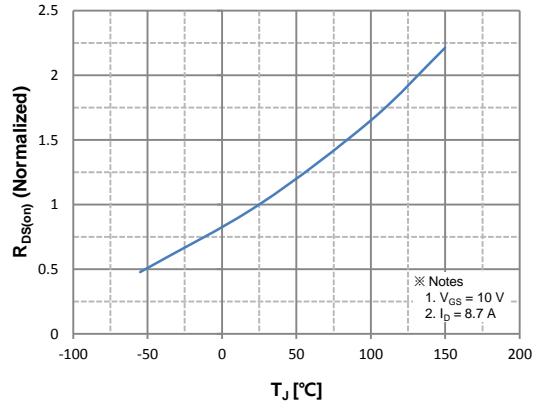

Figure 8. On-Resistance Variation vs. Temperature

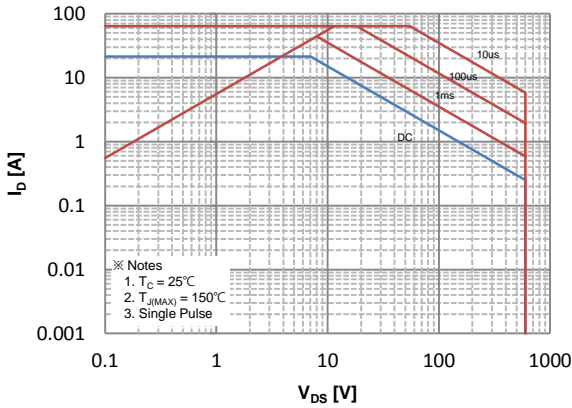

Figure 9. Maximum Safe Operating Area

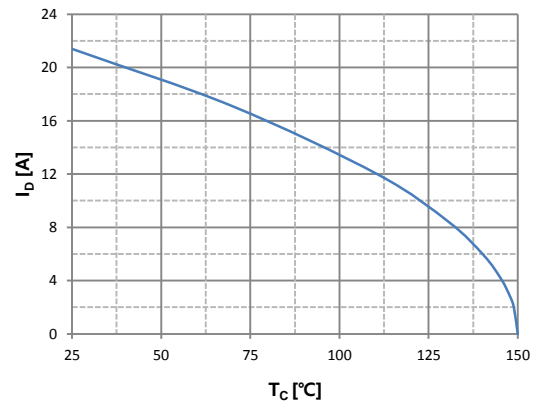

Figure 10. Maximum Drain Current vs. Case Temperature

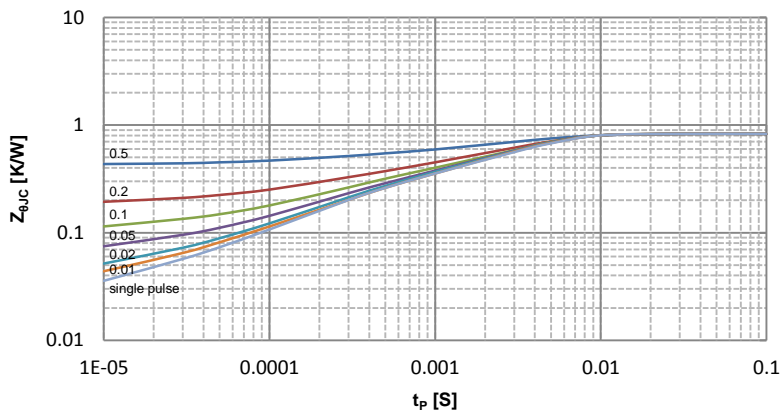

Figure 11. Transient Thermal Response Curve

Fig 12. Gate Charge Test Circuit & Waveform



Fig 13. Resistive Switching Test Circuit & Waveforms



Fig 14. Unclamped Inductive Switching Test Circuit & Waveforms



Fig 15. Peak Diode Recovery dv/dt Test Circuit & Waveforms

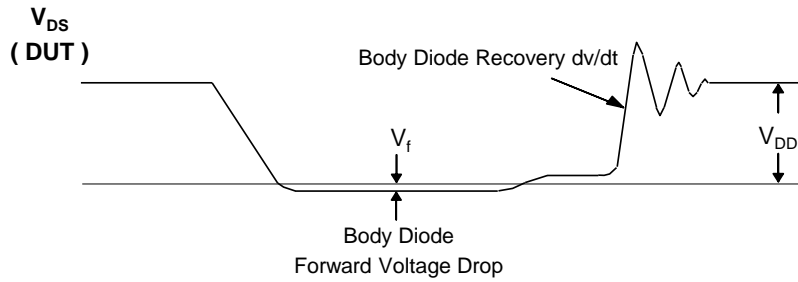
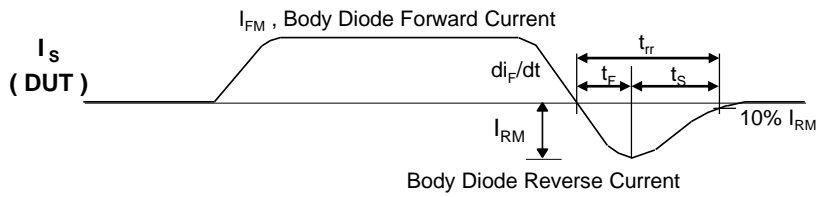
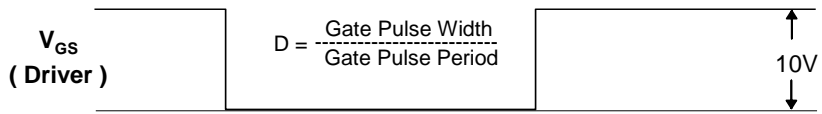
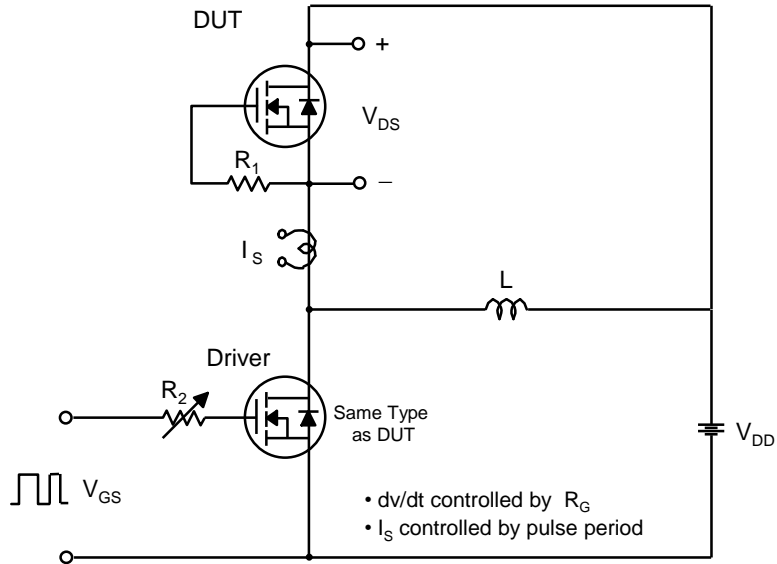

Package Dimension

TO-247

