

HRLFS190N03K

30V N-Channel Trench MOSFET

FEATURES

- ❑ $BV_{DSS} = 30\text{ V}$
- ❑ $I_D = 28\text{ A}$
- ❑ Unrivalled Gate Charge : 12 nC (Typ.)
- ❑ Lower $R_{DS(ON)}$: 16 m Ω (Typ.) @ $V_{GS}=10\text{V}$
- ❑ Lower $R_{DS(ON)}$: 20 m Ω (Typ.) @ $V_{GS}=4.5\text{V}$
- ❑ 100% Avalanche Tested

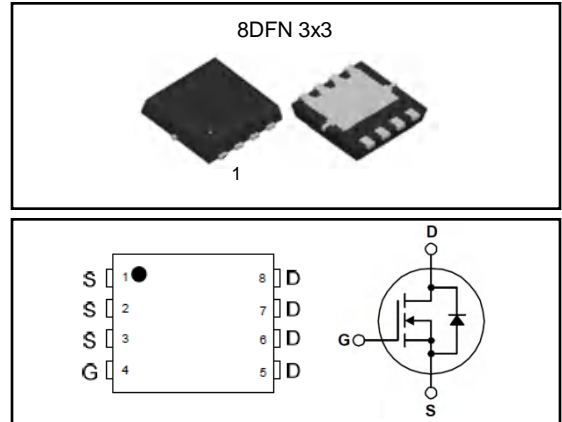

Absolute Maximum Ratings $T_J=25^\circ\text{C}$ unless otherwise specified

Symbol	Parameter	Value	Units	
V_{DSS}	Drain-Source Voltage	30	V	
V_{GS}	Gate-Source Voltage	± 20	V	
I_D	Drain Current	$T_C = 25^\circ\text{C}$	28	A
		$T_C = 100^\circ\text{C}$	18	A
I_{DM}	Pulsed Drain Current (Note 1)	62	A	
E_{AS}	Single Pulsed Avalanche Energy (Note 2)	110	mJ	
P_D	Power Dissipation	$T_C = 25^\circ\text{C}$	23	W
		$T_A = 25^\circ\text{C}$	1.67	W
T_J, T_{STG}	Operating and Storage Temperature Range	-55 to +150	$^\circ\text{C}$	

Thermal Resistance Characteristics

Symbol	Parameter	Typ.	Max.	Units
$R_{\theta JC}$	Junction-to-Case	--	5.4	$^\circ\text{C}/\text{W}$
$R_{\theta JA}$	Junction-to-Ambient (steady state)	--	75	$^\circ\text{C}/\text{W}$

Electrical Characteristics $T_J=25\text{ }^\circ\text{C}$ unless otherwise specified

Symbol	Parameter	Test Conditions	Min	Typ	Max	Units
On Characteristics						
V_{GS}	Gate Threshold Voltage	$V_{DS} = V_{GS}, I_D = 250\ \mu\text{A}$	1.0	--	2.4	V
$R_{DS(ON)}$	Static Drain-Source On-Resistance	$V_{GS} = 10\ \text{V}, I_D = 10\ \text{A}$	--	16	19	m Ω
		$V_{GS} = 4.5\ \text{V}, I_D = 9\ \text{A}$	--	20	25	m Ω
g_{FS}	Forward Transconductance	$V_{DS} = 5, I_D = 10\ \text{A}$	--	10	--	S
Off Characteristics						
BV_{DSS}	Drain-Source Breakdown Voltage	$V_{GS} = 0\ \text{V}, I_D = 250\ \mu\text{A}$	30	--	--	V
I_{DSS}	Zero Gate Voltage Drain Current	$V_{DS} = 24\ \text{V}, V_{GS} = 0\ \text{V}$	--	--	1	μA
		$V_{DS} = 24\ \text{V}, T_J = 125\text{ }^\circ\text{C}$	--	--	100	μA
I_{GSS}	Gate-Body Leakage Current	$V_{GS} = \pm 20\ \text{V}, V_{DS} = 0\ \text{V}$	--	--	± 100	nA
Dynamic Characteristics						
C_{iss}	Input Capacitance	$V_{DS} = 15\ \text{V}, V_{GS} = 0\ \text{V}, f = 1.0\ \text{MHz}$	--	590	--	pF
C_{oss}	Output Capacitance		--	90	--	pF
C_{riss}	Reverse Transfer Capacitance		--	65	--	pF
R_g	Gate Resistance	$V_{GS} = 0\ \text{V}, V_{DS} = 0\ \text{V}, f = 1\ \text{MHz}$	--	2.5	--	Ω
Switching Characteristics						
$t_{d(on)}$	Turn-On Time	$V_{DS} = 15\ \text{V}, I_D = 10\ \text{A}, R_G = 6\ \Omega$	--	12	--	ns
t_r	Turn-On Rise Time		--	15	--	ns
$t_{d(off)}$	Turn-Off Delay Time		--	45	--	ns
t_f	Turn-Off Fall Time		--	12	--	ns
$Q_{g(10V)}$	Total Gate Charge	$V_{DS} = 24\ \text{V}, I_D = 10\ \text{A}, V_{GS} = 10\ \text{V}$	--	12	--	nC
$Q_{g(4.5V)}$	Total Gate Charge		--	6	--	nC
Q_{gs}	Gate-Source Charge		--	2.2	--	nC
Q_{gd}	Gate-Drain Charge		--	1.9	--	nC
Source-Drain Diode Maximum Ratings and Characteristics						
I_S	Continuous Source-Drain Diode Forward Current		--	--	28	A
I_{SM}	Pulsed Source-Drain Diode Forward Current		--	--	62	
V_{SD}	Source-Drain Diode Forward Voltage	$I_S = 10\ \text{A}, V_{GS} = 0\ \text{V}$	--	--	1.3	V
t_{rr}	Reverse Recovery Time	$I_S = 10\ \text{A}, V_{GS} = 0\ \text{V}, di_F/dt = 100\ \text{A}/\mu\text{s}$	--	20	--	ns
Q_{rr}	Reverse Recovery Charge		--	10	--	nC

Notes :

1. Repetitive Rating : Pulse width limited by maximum junction temperature
2. $L=1\ \text{mH}, I_{AS}=6\ \text{A}, V_{DD}=25\ \text{V}, R_G=25\ \Omega,$ Starting $T_J=25\text{ }^\circ\text{C}$

Typical Characteristics

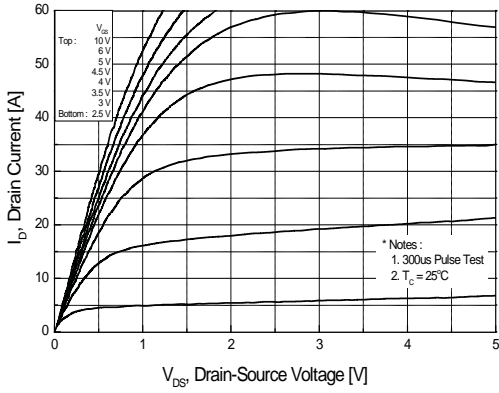

Figure 1. On Region Characteristics

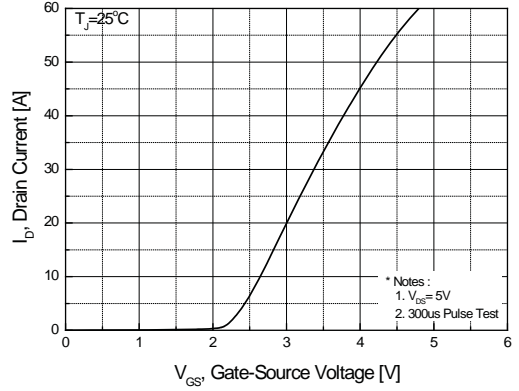

Figure 2. Transfer Characteristics

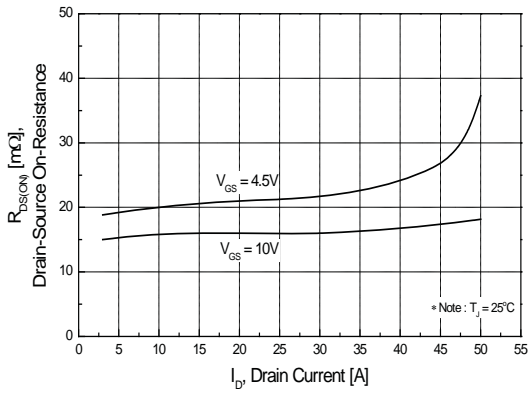

Figure 3. On Resistance Variation vs Drain Current and Gate Voltage

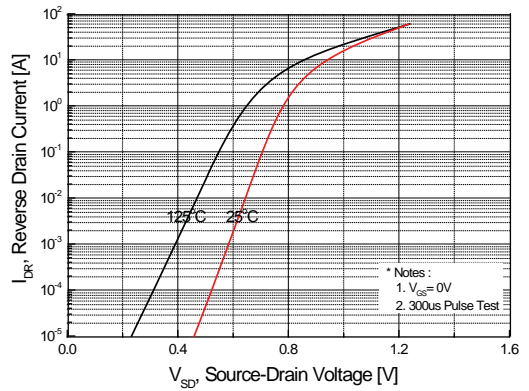

Figure 4. Body Diode Forward Voltage Variation with Source Current and Temperature

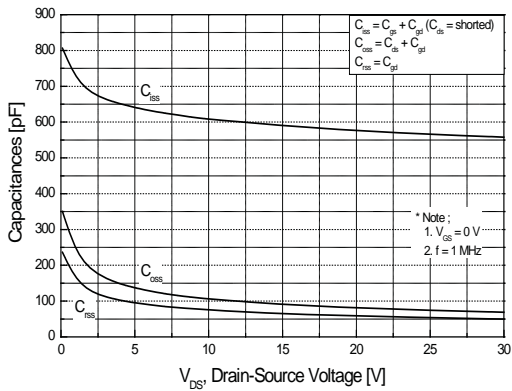

Figure 5. Capacitance Characteristics

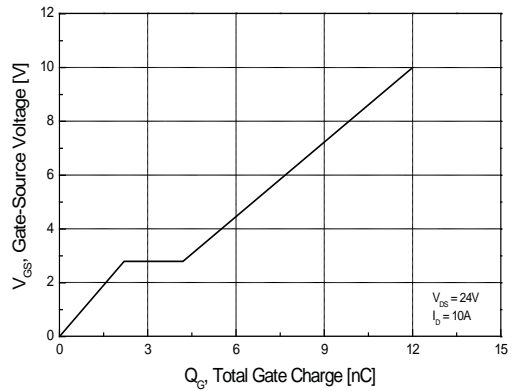

Figure 6. Gate Charge Characteristics

Typical Characteristics (continued)

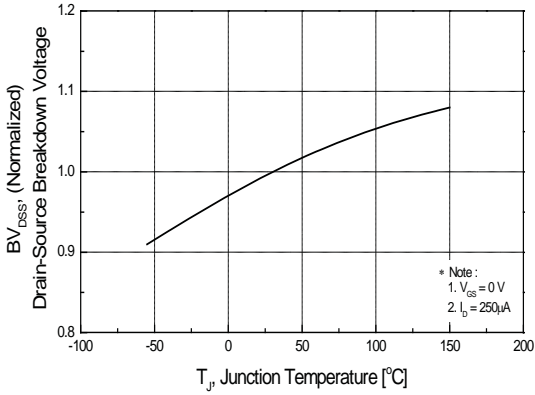

Figure 7. Breakdown Voltage Variation vs Temperature

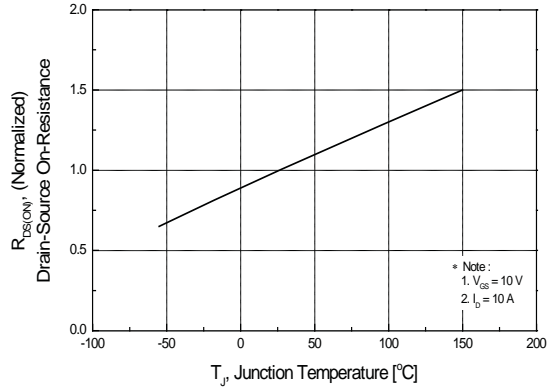

Figure 8. On-Resistance Variation vs Temperature

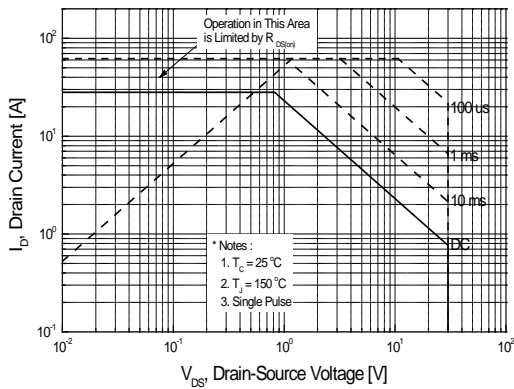

Figure 9. Maximum Safe Operating Area

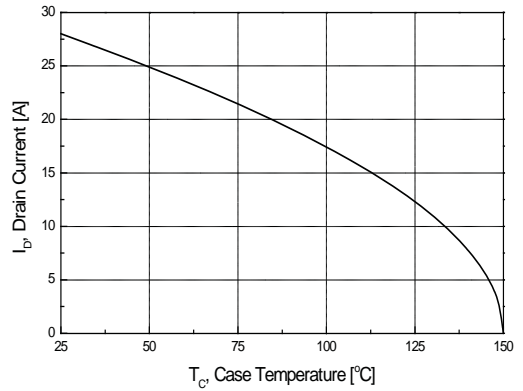

Figure 10. Maximum Drain Current vs Case Temperature

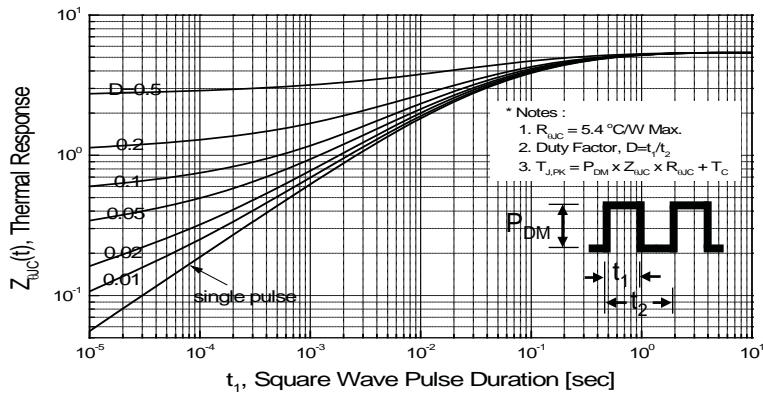

Figure 11. Transient Thermal Response Curve

Fig 12. Gate Charge Test Circuit & Waveform



Fig 13. Resistive Switching Test Circuit & Waveforms

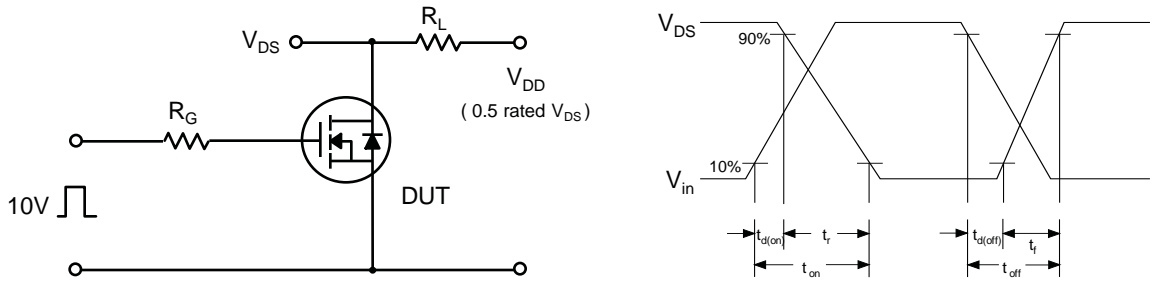

Fig 14. Unclamped Inductive Switching Test Circuit & Waveforms

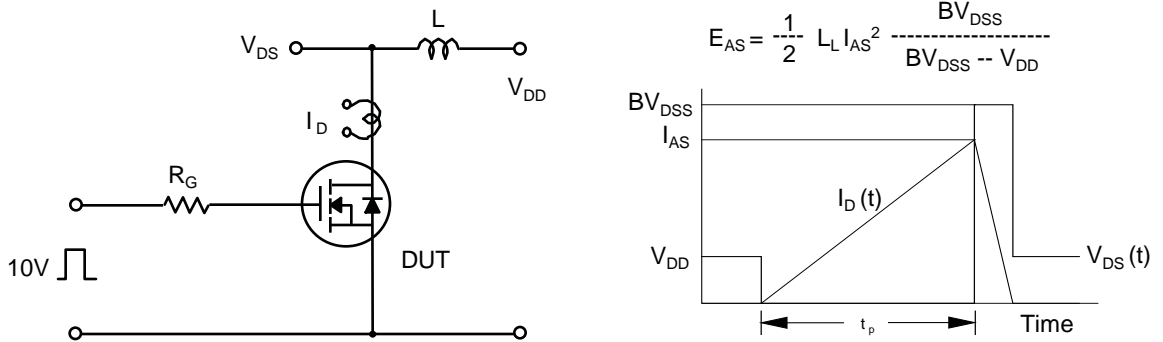
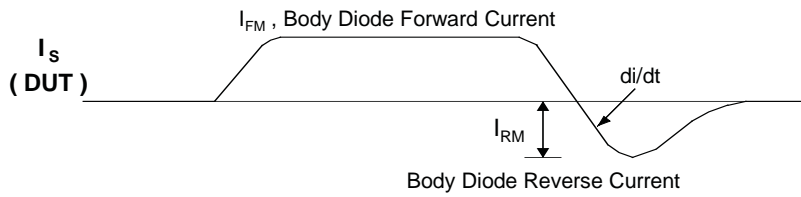
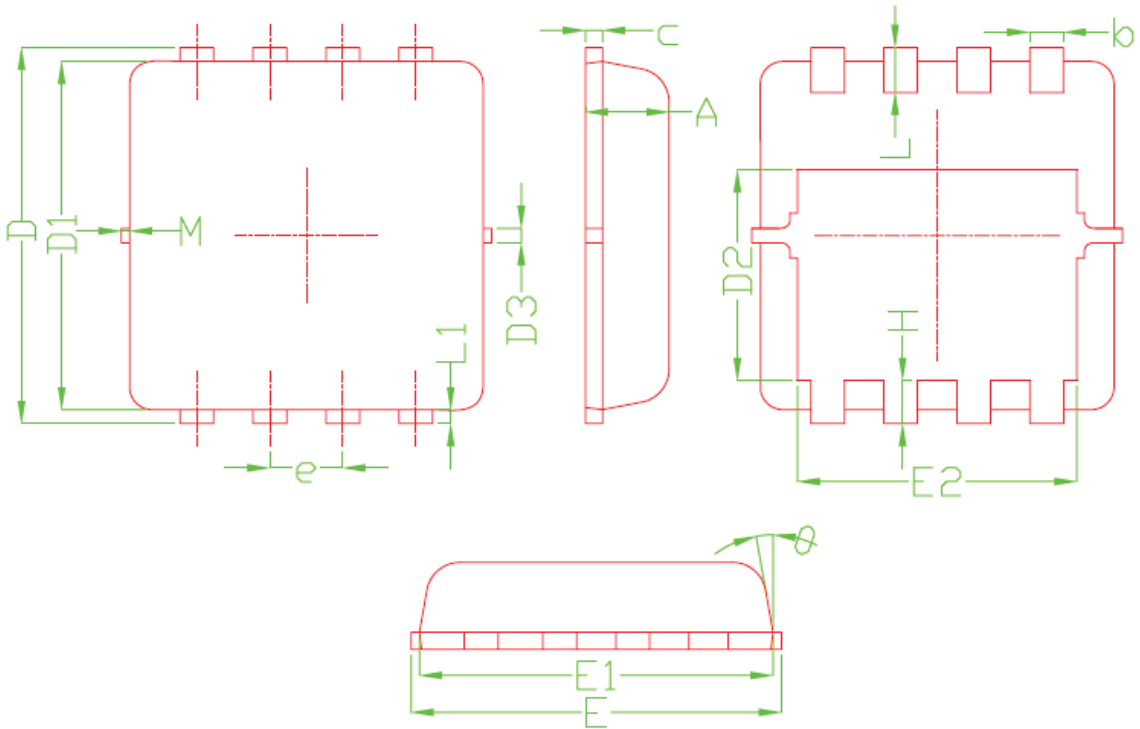

Fig 15. Peak Diode Recovery dv/dt Test Circuit & Waveforms



Package Dimension

8DFN 3x3



SYMBOL	DIMENSIONAL REOMTS		
	MIN	NOM	MAX
A	0.70	0.75	0.80
b	0.25	0.30	0.35
c	0.10	0.15	0.25
D	3.25	3.35	3.45
D1	3.00	3.10	3.20
D2	1.78	1.88	1.98
D3	---	0.13	---
E	3.20	3.30	3.40
E1	3.00	3.15	3.20
E2	2.39	2.49	2.59
e	0.65BSC		
H	0.30	0.39	0.50
L	0.30	0.40	0.50
L1	---	0.13	---
theta	---	10°	12°
M	*	*	0.15

* Not specified

