

HRLD72N06

65V N-Channel Trench MOSFET

Features

- High Speed Power Switching, Logic Level
- Enhanced Body diode dv/dt capability
- Enhanced Avalanche Ruggedness
- 100% UIS Tested, 100% Rg Tested
- Lead free, Halogen Free

Application

- Synchronous Rectification in SMPS
- Hard Switching and High Speed Circuit
- DC/DC in Telecoms and Industrial

Key Parameters

Parameter	Value	Unit
BV_{DSS}	65	V
I_D	73	A
$R_{DS(on), max @10V}$	7.2	m Ω
$R_{DS(on), max @4.5V}$	12.5	m Ω

Package & Internal Circuit

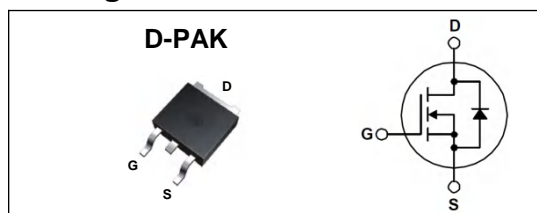

Absolute Maximum Ratings $T_J=25^\circ\text{C}$ unless otherwise specified

Symbol	Parameter	Value	Units	
V_{DSS}	Drain-Source Voltage	65	V	
V_{GS}	Gate-Source Voltage	± 20	V	
I_D	Drain Current	$T_C = 25^\circ\text{C}$	73	A
		$T_C = 100^\circ\text{C}$	46	A
I_{DM}	Pulsed Drain Current	292	A	
E_{AS}	Single Pulsed Avalanche Energy	12.5	mJ	
P_D	Power Dissipation	$T_C = 25^\circ\text{C}$	96	W
		$T_A = 25^\circ\text{C}$	1.1	W
T_J, T_{STG}	Operating and Storage Temperature Range	-55 to +150	$^\circ\text{C}$	

Thermal Resistance Characteristics

Symbol	Parameter	Typ.	Max.	Units
$R_{\theta JC}$	Junction-to-Case	--	1.3	$^\circ\text{C/W}$
$R_{\theta JA}$	Junction-to-Ambient (steady state)	--	110	$^\circ\text{C/W}$

Electrical Characteristics $T_J=25^\circ\text{C}$ unless otherwise specified

Symbol	Parameter	Test Conditions	Min	Typ	Max	Units
On Characteristics						
V_{GS}	Gate Threshold Voltage	$V_{DS} = V_{GS}, I_D = 250 \mu\text{A}$	1.0	--	2.5	V
$R_{DS(ON)}$	Static Drain-Source On-Resistance	$V_{GS} = 10 \text{ V}, I_D = 20 \text{ A}$	--	6.0	7.2	m Ω
		$V_{GS} = 4.5 \text{ V}, I_D = 15 \text{ A}$	--	9.6	12.5	m Ω
g_{FS}	Forward Transconductance	$V_{DS} = 10 \text{ V}, I_D = 3 \text{ A}$	--	10	--	S
Off Characteristics						
BV_{DSS}	Drain-Source Breakdown Voltage	$V_{GS} = 0 \text{ V}, I_D = 250 \mu\text{A}$	65	--	--	V
I_{DSS}	Zero Gate Voltage Drain Current	$V_{DS} = 60 \text{ V}, V_{GS} = 0 \text{ V}$	--	--	1	μA
		$V_{DS} = 48 \text{ V}, T_J = 85^\circ\text{C}$	--	--	10	μA
I_{GSS}	Gate-Body Leakage Current	$V_{GS} = \pm 20 \text{ V}, V_{DS} = 0 \text{ V}$	--	--	± 1	μA
Dynamic Characteristics						
C_{iss}	Input Capacitance	$V_{DS} = 30 \text{ V}, V_{GS} = 0 \text{ V}, f = 1.0 \text{ MHz}$	--	1575	--	pF
C_{oss}	Output Capacitance		--	785	--	pF
C_{rss}	Reverse Transfer Capacitance		--	30	--	pF
R_g	Gate Resistance	$V_{GS} = 0 \text{ V}, V_{DS} = 0 \text{ V}, f = 1\text{MHz}$	--	1.25	--	Ω
Switching Characteristics						
$t_{d(on)}$	Turn-On Time	$V_{DS} = 30 \text{ V}, I_D = 10 \text{ A}, R_G = 10 \Omega$	--	15	--	ns
t_r	Turn-On Rise Time		--	21	--	ns
$t_{d(off)}$	Turn-Off Delay Time		--	136	--	ns
t_f	Turn-Off Fall Time		--	27	--	ns
Q_g	Total Gate Charge	$V_{DS} = 30 \text{ V}, I_D = 10 \text{ A}, V_{GS} = 10 \text{ V}$	--	38.5	--	nC
Q_{gs}	Gate-Source Charge		--	7.5	--	nC
Q_{gd}	Gate-Drain Charge		--	4.5	--	nC
Source-Drain Diode Characteristics						
V_{SD}	Source-Drain Diode Forward Voltage	$I_S = 1 \text{ A}, V_{GS} = 0 \text{ V}$	--	0.9	1.2	V
t_{rr}	Reverse Recovery Time	$I_S = 10 \text{ A}, V_{GS} = 10 \text{ V}, di_F/dt = 100 \text{ A}/\mu\text{s}$	--	48.4	--	ns
Q_{rr}	Reverse Recovery Charge		--	54.2	--	nC

Notes :

1. Repetitive Rating : Pulse width limited by maximum junction temperature
2. $I_{AS}=5\text{A}, V_{DD}=30\text{V}, R_G=25\Omega, \text{Starting } T_J=25^\circ\text{C}$

Typical Characteristics

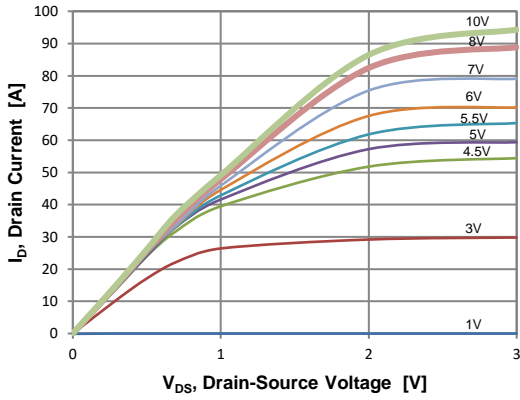

Figure 1. On Region Characteristics

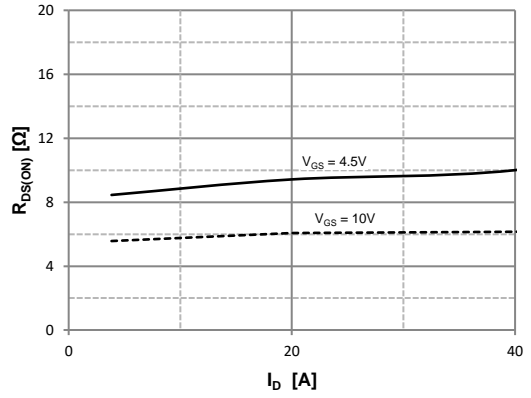

Figure 2. On Resistance Variation vs Drain Current and Gate Voltage

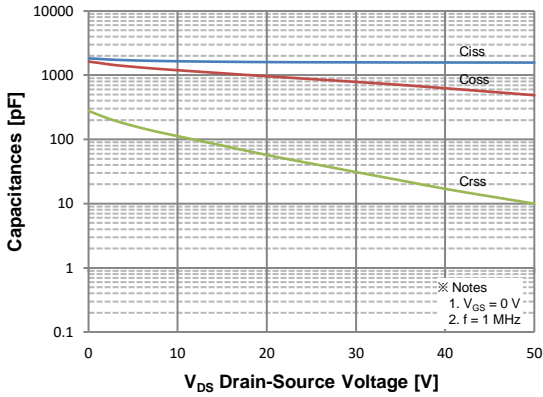

Figure 3. Capacitance Characteristics

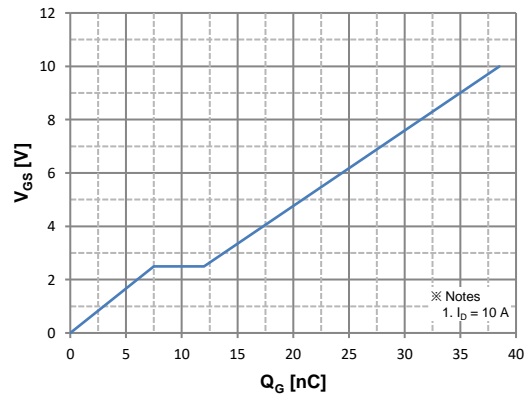

Figure 4. Gate Charge Characteristics

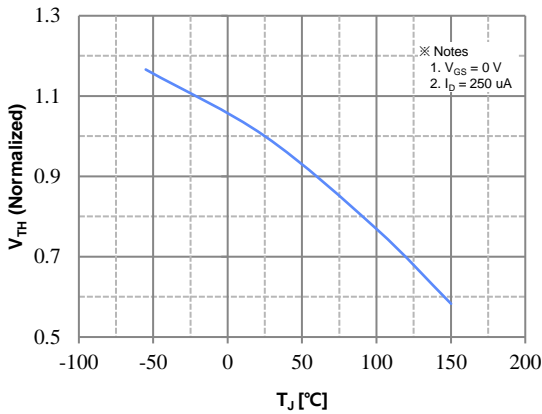

Figure 4. Gate Threshold Voltage vs Temperature

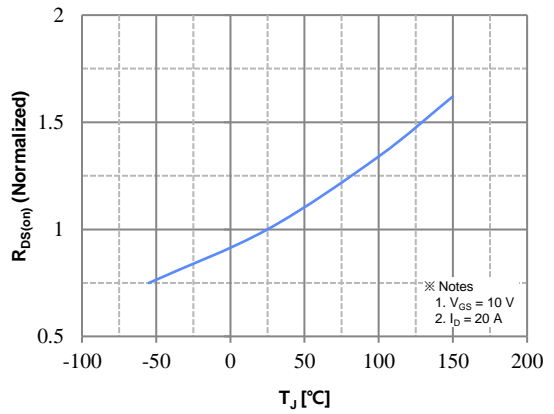

Figure 6. On-Resistance Variation vs Temperature

Typical Characteristics (continued)

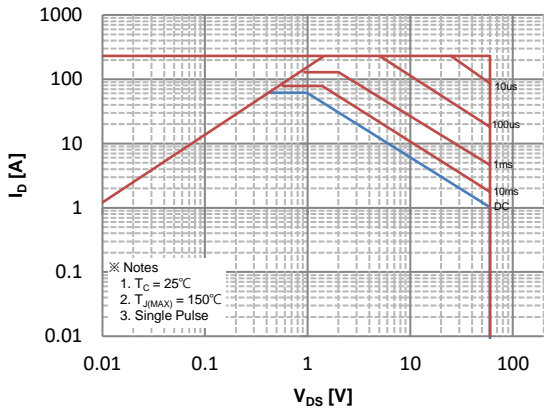

Figure 7. Maximum Safe Operating Area

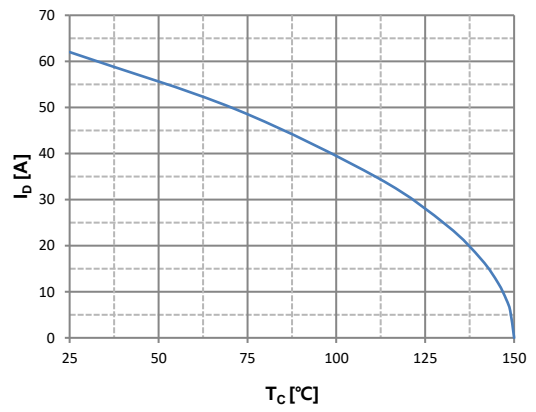

Figure 8. Maximum Drain Current vs Case Temperature

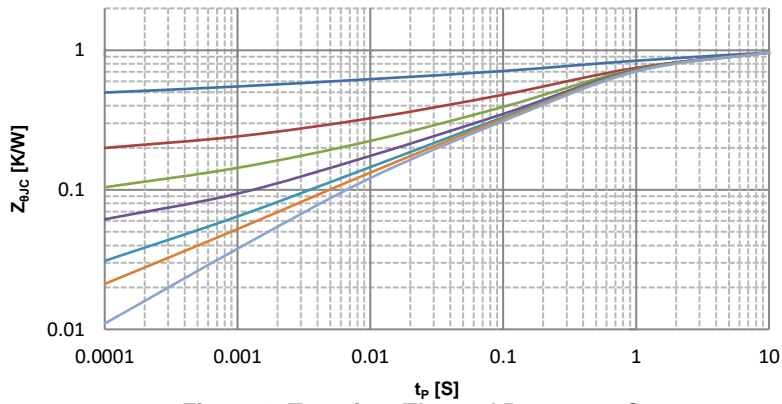

Figure 9. Transient Thermal Response Curve

Fig 12. Gate Charge Test Circuit & Waveform

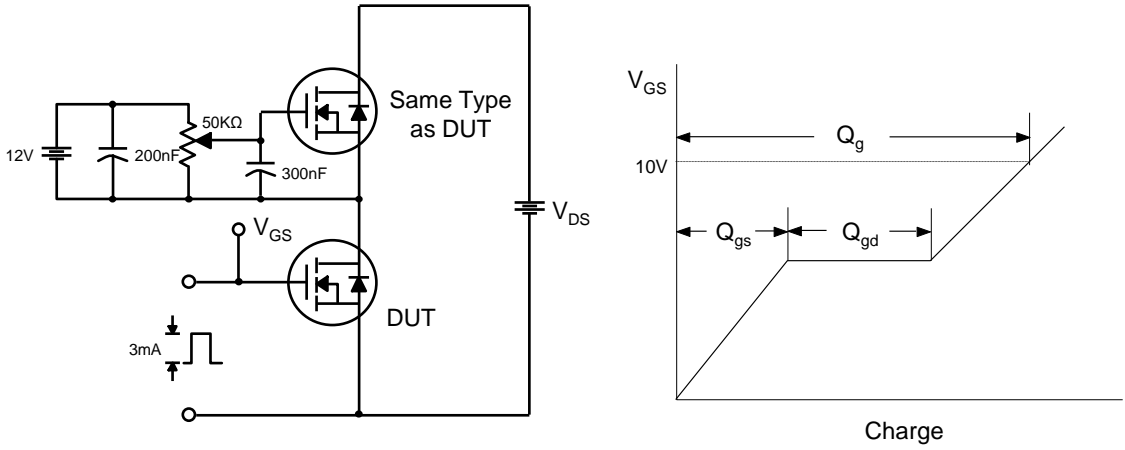

Fig 13. Resistive Switching Test Circuit & Waveforms

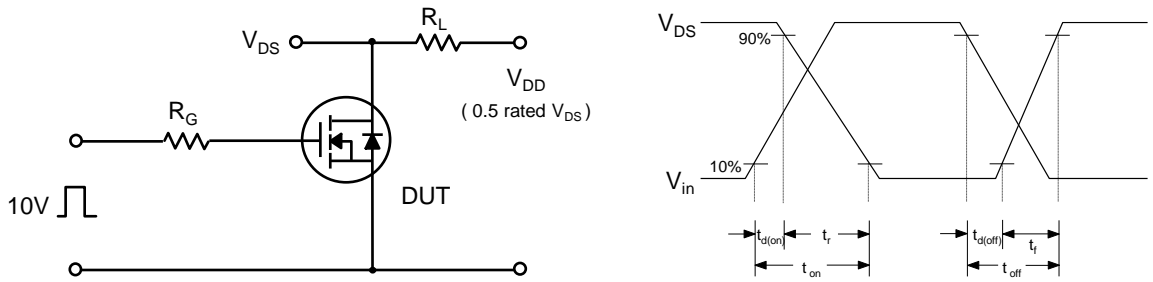

Fig 14. Unclamped Inductive Switching Test Circuit & Waveforms

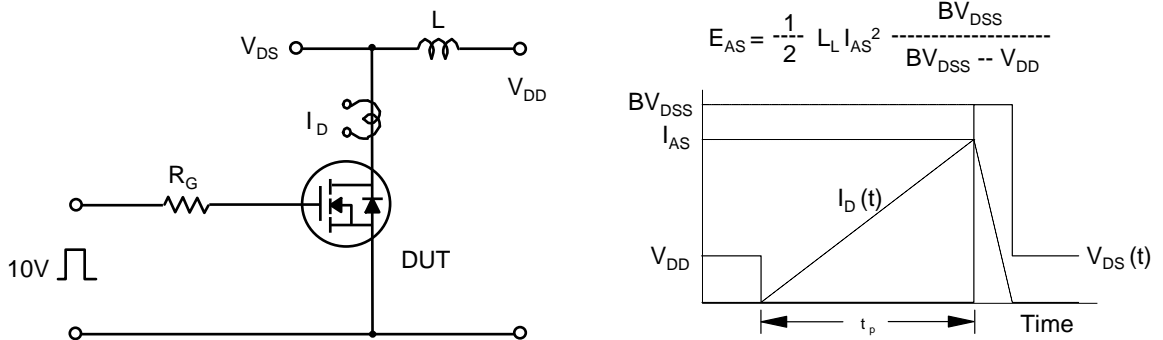
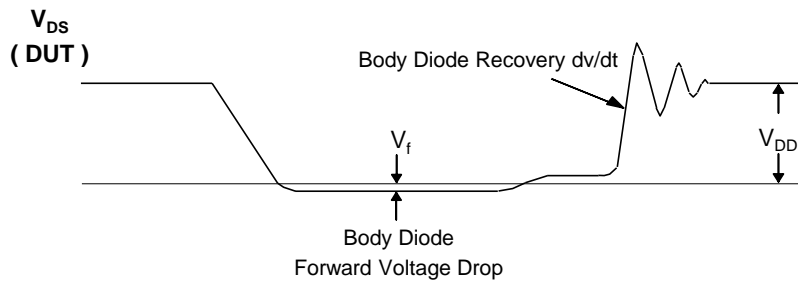
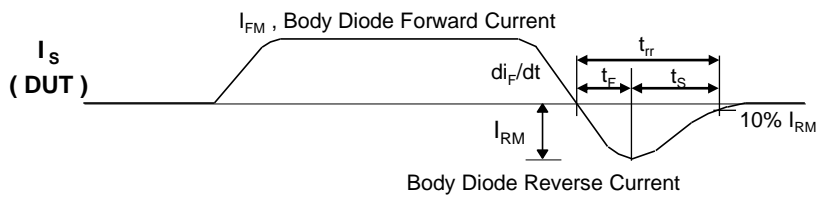
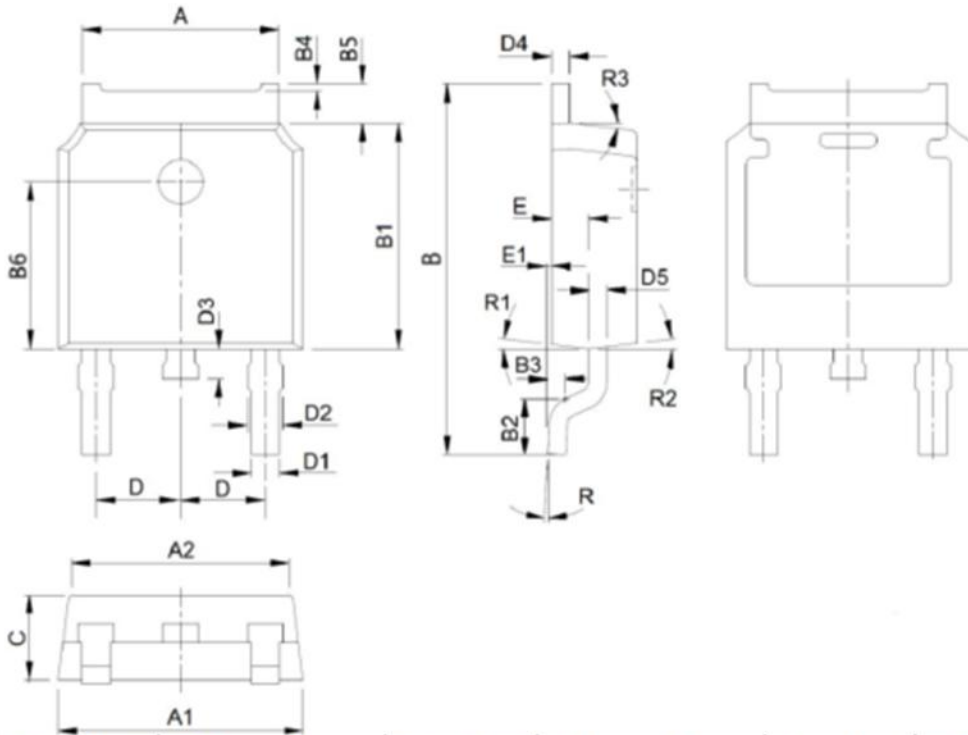

Fig 15. Peak Diode Recovery dv/dt Test Circuit & Waveforms



Package Dimension

D-PAK
(TO-252A)



Symbol	Dimensions (mm)	Symbol	Dimensions (mm)	Symbol	Dimensions (mm)
A	5.3±0.2	B5	0.95±0.1	D5	0.5±0.08
A1	6.6±0.2	B6	4.5±0.15	E	1.01±0.15
A2	5.8±0.2	C	2.3±0.15	E1	0.1±0.05
B	9.9±0.4	D	2.286 (typ.)	R	3° ±3°
B1	6.1±0.2	D1	0.76±0.1	R1	7° (typ.)
B2	1.5±0.15	D2	0.91±0.1	R2	7° (typ.)
B3	0.5±0.1	D3	0.8±0.15	R3	7° (typ.)
B4	0.1 (typ.)	D4	0.5±0.08		

变更前	
D1	0.62±0.15
D2	0.75±0.15