

# HRLD1B8N10K / HRLU1B8N10K

## 100V N-Channel Trench MOSFET

$BV_{DSS} = 100\text{ V}$   
 $R_{DS(on) \text{ typ}} = 140\text{ m}\Omega$   
 $I_D = 2.7\text{ A}$

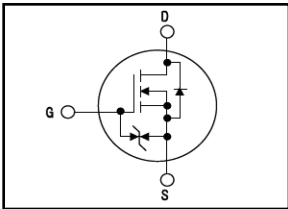
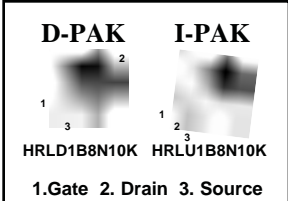

### FEATURES

- Originative New Design
- Superior Avalanche Rugged Technology
- Excellent Switching Characteristics
- Unrivalled Gate Charge : 11.5 nC (Typ.)
- Extended Safe Operating Area
- Lower  $R_{DS(ON)}$  : 140 m $\Omega$  (Typ.) @  $V_{GS}=10\text{V}$
- Lower  $R_{DS(ON)}$  : 185 m $\Omega$  (Typ.) @  $V_{GS}=4.5\text{V}$
- Built-in ESD Diode
- 100% Avalanche Tested

### Absolute Maximum Ratings $T_C=25^\circ\text{C}$ unless otherwise specified

Symbol	Parameter	Value	Units
$V_{DSS}$	Drain-Source Voltage	100	V
$I_D$	Drain Current – Continuous ( $T_C = 25^\circ\text{C}$ )	2.7	A
	Drain Current – Continuous ( $T_C = 70^\circ\text{C}$ )	2.1	A
$I_{DM}$	Drain Current – Pulsed (Note 1)	10.0	A
$V_{GS}$	Gate-Source Voltage	$\pm 16$	V
$E_{AS}$	Single Pulsed Avalanche Energy (Note 2)	22	mJ
$I_{AR}$	Avalanche Current (Note 1)	2.7	A
$P_D$	Power Dissipation ( $T_A = 25^\circ\text{C}$ )*	2.5	W
	Power Dissipation ( $T_C = 25^\circ\text{C}$ ) - Derate above $25^\circ\text{C}$	33	W
		0.26	W/ $^\circ\text{C}$
$T_J, T_{STG}$	Operating and Storage Temperature Range	-55 to +150	$^\circ\text{C}$
$T_L$	Maximum lead temperature for soldering purposes, 1/8" from case for 5 seconds	300	$^\circ\text{C}$

### Thermal Resistance Characteristics

Symbol	Parameter	Typ.	Max.	Units
$R_{\theta JC}$	Junction-to-Case	--	3.8	$^\circ\text{C}/\text{W}$
$R_{\theta JA}$	Junction-to-Ambient*	--	50	
$R_{\theta JA}$	Junction-to-Ambient	--	110	

\* When mounted on the minimum pad size recommended (PCB Mount)

**Electrical Characteristics**  $T_J=25\text{ }^\circ\text{C}$  unless otherwise specified

Symbol	Parameter	Test Conditions	Min	Typ	Max	Units
<b>On Characteristics</b>						
$V_{GS}$	Gate Threshold Voltage	$V_{DS} = V_{GS}, I_D = 250\ \mu\text{A}$	1.2	--	2.8	V
$R_{DS(ON)}$	Static Drain-Source On-Resistance	$V_{GS} = 10\ \text{V}, I_D = 2.7\ \text{A}$	--	140	180	m $\Omega$
		$V_{GS} = 4.5\ \text{V}, I_D = 2\ \text{A}$	--	185	240	m $\Omega$
<b>Off Characteristics</b>						
$BV_{DSS}$	Drain-Source Breakdown Voltage	$V_{GS} = 0\ \text{V}, I_D = 250\ \mu\text{A}$	100	--	--	V
$I_{DSS}$	Zero Gate Voltage Drain Current	$V_{DS} = 80\ \text{V}, V_{GS} = 0\ \text{V}$	--	--	1	$\mu\text{A}$
		$V_{DS} = 80\ \text{V}, T_J = 125\text{ }^\circ\text{C}$	--	--	100	$\mu\text{A}$
$I_{GSS}$	Gate-Body Leakage Current	$V_{GS} = \pm 16\ \text{V}, V_{DS} = 0\ \text{V}$	--	--	$\pm 10$	$\mu\text{A}$
<b>Dynamic Characteristics</b>						
$C_{iss}$	Input Capacitance	$V_{DS} = 30\ \text{V}, V_{GS} = 0\ \text{V},$ $f = 1.0\ \text{MHz}$	--	440	570	pF
$C_{oss}$	Output Capacitance		--	36	47	pF
$C_{rss}$	Reverse Transfer Capacitance		--	20	26	pF
<b>Switching Characteristics</b>						
$t_{d(on)}$	Turn-On Time	$V_{DS} = 50\ \text{V}, I_D = 2.7\ \text{A},$ $R_G = 25\ \Omega$  (Note 4,5)	--	12	34	ns
$t_r$	Turn-On Rise Time		--	16	42	ns
$t_{d(off)}$	Turn-Off Delay Time		--	55	120	ns
$t_f$	Turn-Off Fall Time		--	20	50	ns
$Q_g$	Total Gate Charge	$V_{DS} = 80\ \text{V}, I_D = 2.7\ \text{A},$ $V_{GS} = 10\ \text{V}$  (Note 4,5)	--	11.5	15	nC
$Q_{gs}$	Gate-Source Charge		--	1.5	--	nC
$Q_{gd}$	Gate-Drain Charge		--	2.5	--	nC
<b>Source-Drain Diode Maximum Ratings and Characteristics</b>						
$I_S$	Continuous Source-Drain Diode Forward Current		--	--	2.7	A
$I_{SM}$	Pulsed Source-Drain Diode Forward Current		--	--	10	
$V_{SD}$	Source-Drain Diode Forward Voltage	$I_S = 2.7\ \text{A}, V_{GS} = 0\ \text{V}$	--	--	1.1	V
$t_{rr}$	Reverse Recovery Time	$I_S = 2\ \text{A}, V_{GS} = 0\ \text{V}$ $di_F/dt = 100\ \text{A}/\mu\text{s}$ (Note 4)	--	43	--	ns
$Q_{rr}$	Reverse Recovery Charge		--	73	--	nC

**Notes ;**

1. Repetitive Rating : Pulse width limited by maximum junction temperature
2.  $L=1\text{mH}, I_{SD}\leq 5.5\text{A}, V_{DD}=25\text{V}, R_G=25\Omega,$  Starting  $T_J=25\text{ }^\circ\text{C}$
3.  $I_{SD}\leq 2.7\text{A}, di/dt\leq 200\text{A}/\mu\text{s}, V_{DD}\leq BV_{DSS},$  Starting  $T_J=25\text{ }^\circ\text{C}$
4. Pulse Test : Pulse Width  $\leq 300\mu\text{s},$  Duty Cycle  $\leq 2\%$
5. Essentially Independent of Operating Temperature

## Typical Characteristics

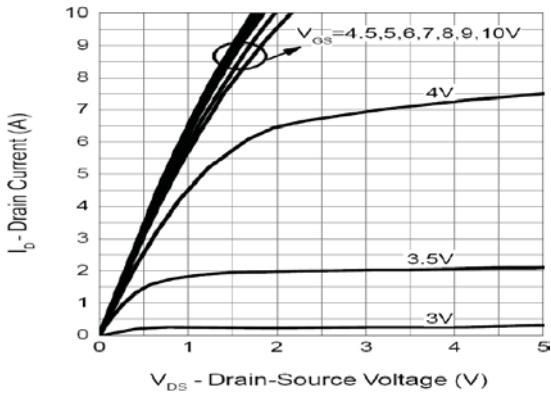

Figure 1. On Region Characteristics

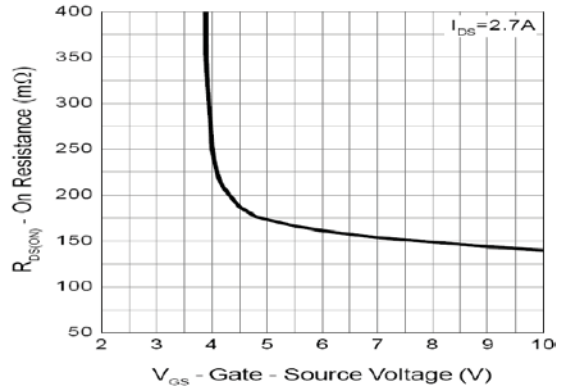

Figure 2. Gate-Source On Resistance

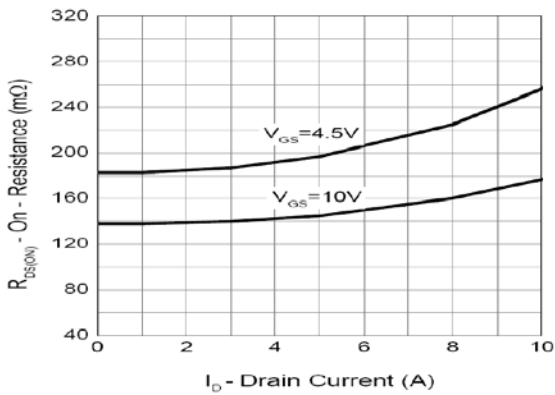

Figure 3. On Resistance Variation vs Drain Current and Gate Voltage

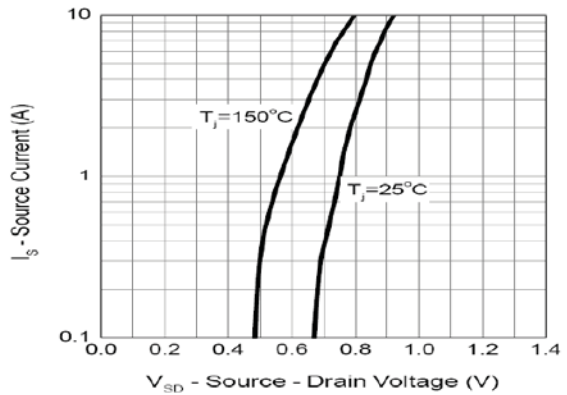

Figure 4. Body Diode Forward Voltage Variation with Source Current and Temperature

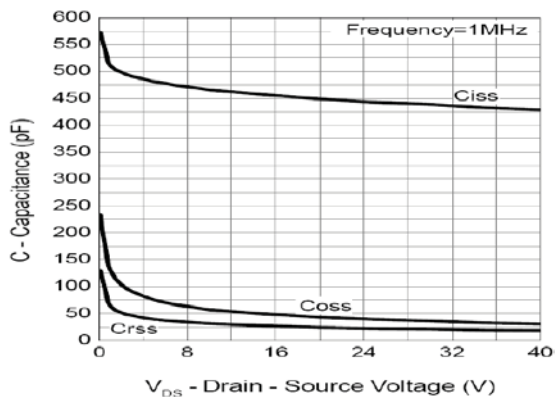

Figure 5. Capacitance Characteristics

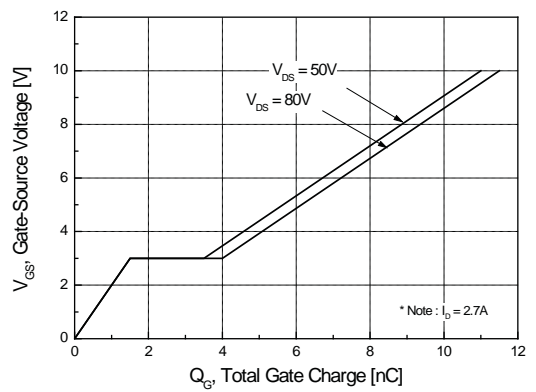
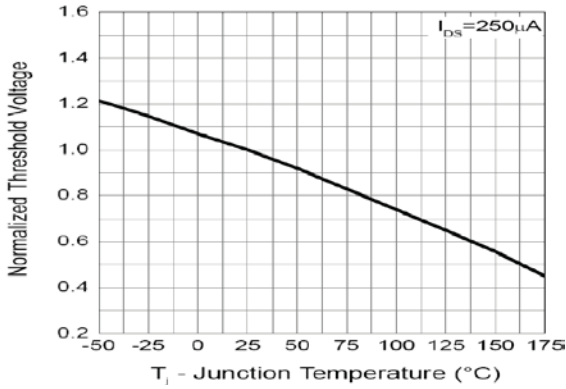
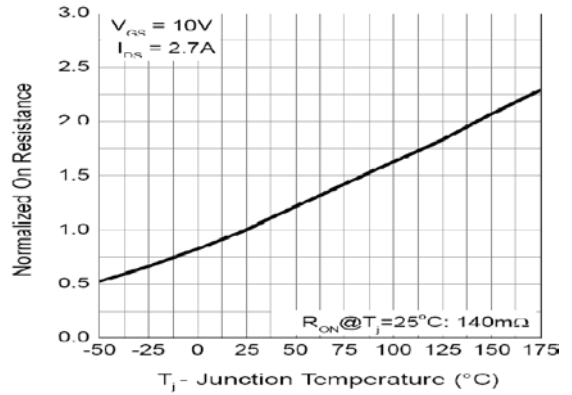

Figure 6. Gate Charge Characteristics

**Typical Characteristics (continued)**



**Figure 7. Gate Threshold Voltage vs Temperature**



**Figure 8. On-Resistance Variation vs Temperature**

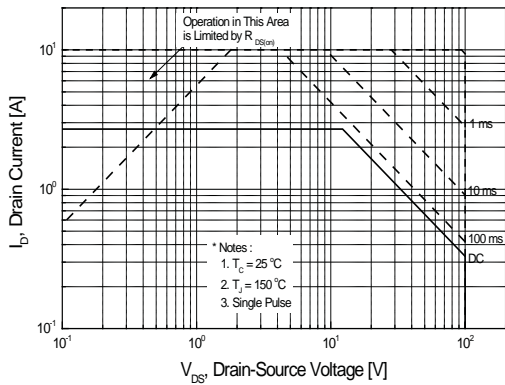

**Figure 9. Maximum Safe Operating Area**

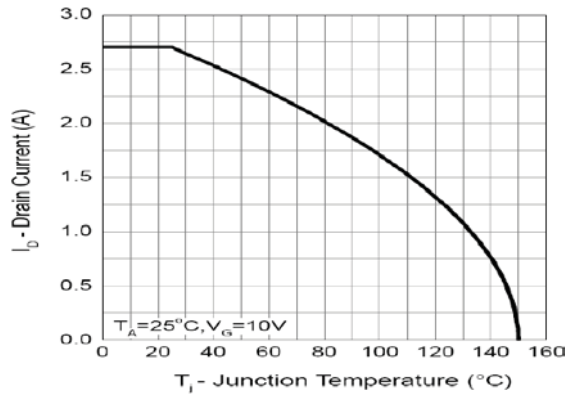

**Figure 10. Maximum Drain Current vs Case Temperature**

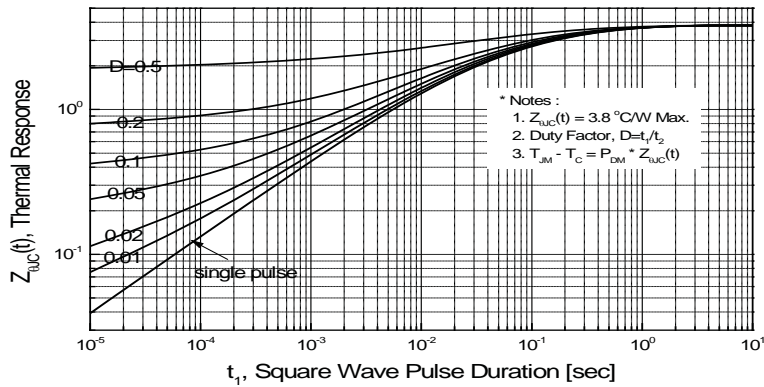

**Figure 11. Transient Thermal Response Curve**

**Fig 12. Gate Charge Test Circuit & Waveform**



**Fig 13. Resistive Switching Test Circuit & Waveforms**



**Fig 14. Unclamped Inductive Switching Test Circuit & Waveforms**

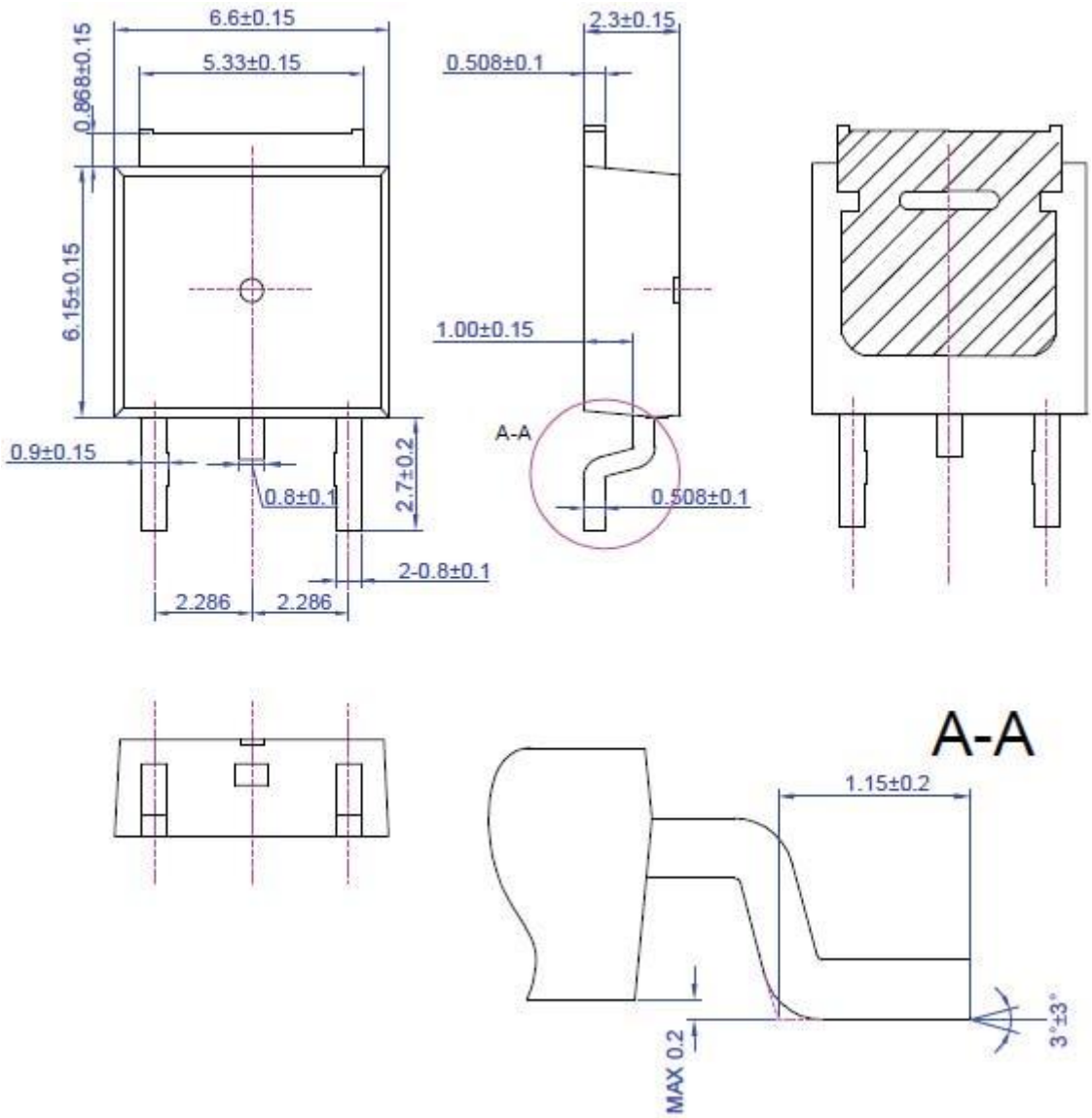

**Fig 15. Peak Diode Recovery dv/dt Test Circuit & Waveforms**



Package Dimension

D-PAK  
(TO-252A)



Package Dimension

I-PAK  
(TO-251A)

