

Feature

- 100V,90A
 $R_{DS(ON)} < 7.7m\Omega @ V_{GS}=10V$ (TYP:6.2m Ω)
 $R_{DS(ON)} < 10m\Omega @ V_{GS}=4.5V$ (TYP:8.0m Ω)
- Split Gate Trench Technology
- Lead free product is acquired
- Excellent $R_{DS(ON)}$ and Low Gate Charge

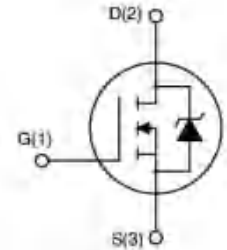

Application

- PWM applications
- Load Switch
- Power management

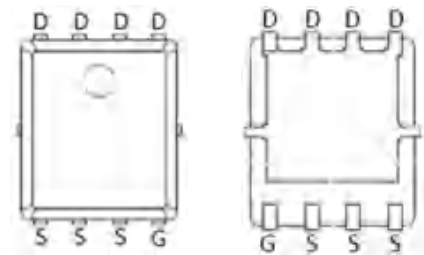

PDFN5X6-8L

Package Marking and Ordering Information

Device Marking	Device	Device Package	Reel Size	Tape width	Quantity (PCS)
G077N01G	APG077N01G	PDFN5*6-8L	-	-	5000

ABSOLUTE MAXIMUM RATINGS ($T_a=25^\circ\text{C}$ unless otherwise noted)

Parameter	Symbol	Value	Unit
Drain-Source Voltage	V_{DS}	100	V
Gate-Source Voltage	V_{GS}	± 25	V
Continuous Drain Current ($T_a=25^\circ\text{C}$)	I_D	90	A
Continuous Drain Current ($T_a=100^\circ\text{C}$)	I_D	60	A
Pulsed Drain Current ⁽¹⁾	I_{DM}	360	A
Singel Pulsed Avalanche Energy ⁽²⁾	E_{AS}	225	mJ
Power Dissipation	P_D	105	W
Thermal Resistance from Junction to Case	$R_{\theta JC}$	1.2	$^\circ\text{C/W}$
Junction Temperature	T_J	150	$^\circ\text{C}$
Storage Temperature	T_{STG}	-55~ +150	$^\circ\text{C}$

MOSFET ELECTRICAL CHARACTERISTICS(T_a=25°C unless otherwise noted)

Parameter	Symbol	Test Condition	Min	Type	Max	Unit
Static Characteristics						
Drain-source breakdown voltage	V _{(BR)DSS}	V _{GS} = 0V, I _D =250μA	100	-	-	V
Zero gate voltage drain current	I _{DSS}	V _{DS} =100V, V _{GS} = 0V	-	-	1	μA
Gate-body leakage current	I _{GSS}	V _{GS} = ±25V, V _{DS} = 0V	-	-	±100	nA
Gate threshold voltage ⁽³⁾	V _{GS(th)}	V _{DS} =V _{GS} , I _D =250μA	1.5	2.0	3.0	V
Drain-source on-resistance ⁽³⁾	R _{DS(on)}	V _{GS} =10V, I _D =40A	-	6.2	7.7	mΩ
		V _{GS} =4.5V, I _D =40A	-	8.0	10	mΩ
Forward Threshold Voltage	g _{fs}	V _{DS} =10V, I _D =40A	-	65	-	S
Gate Resistance	R _g	V _{DS} =V _{GS} =0V, f =1MHz	-	1.3	-	Ω
Dynamic characteristics						
Input Capacitance	C _{iss}	V _{DS} =50V, V _{GS} =0V, f =1MHz	-	3000	-	pF
Output Capacitance	C _{oss}		-	362	-	
Reverse Transfer Capacitance	C _{rss}		-	11	-	
Switching characteristics						
Turn-on delay time	t _{d(on)}	V _{DD} =50V, I _D =40A, V _{GS} =10V, R _G =3Ω	-	13	-	ns
Turn-on rise time	t _r		-	35	-	
Turn-off delay time	t _{d(off)}		-	20	-	
Turn-off fall time	t _f		-	15	-	
Total Gate Charge	Q _g	V _{DS} =50V, I _D =40A, V _{GS} =10V	-	30	-	nC
Gate-Source Charge	Q _{gs}		-	10	-	
Gate-Drain Charge	Q _{gd}		-	8	-	
Reverse Recovery Charge	Q _{rr}	I _F =40A, di/dt=100A/us		90		nC
Reverse Recovery Time	T _{rr}	I _F =40A, di/dt=100A/us		60		ns
Source-Drain Diode characteristics						
Diode Forward voltage ⁽³⁾	V _{DS}	V _{GS} =0V, I _S =20A	-	-	1.3	V
Diode Forward current ⁽⁴⁾	I _S		-	-	60	A

Notes:

1. Repetitive Rating: pulse width limited by maximum junction temperature
2. EAS Condition: T_J=25°C, V_{DD}=50V, R_G=25 Ω, L=0.5Mh, I_{AS}=30A
3. Pulse Test: pulse width ≤300μs, duty cycle ≤2%
4. Surface Mounted on FR4 Board, t ≤10 sec

Test Circuit & Waveform

Gate Charge Test Circuit & Waveform

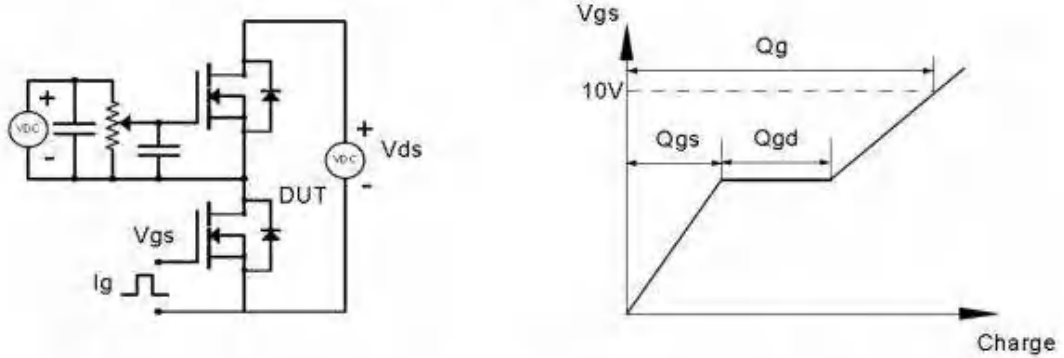

Resistive Switching Test Circuit & Waveforms

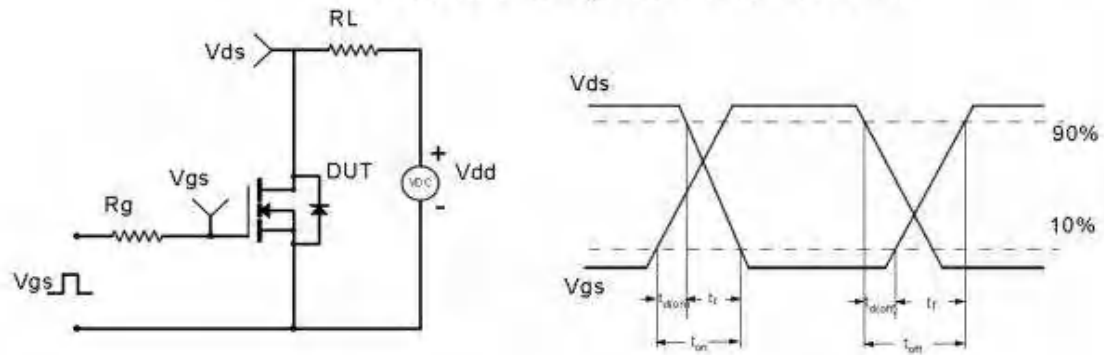

Unclamped Inductive Switching (UIS) Test Circuit & Waveforms

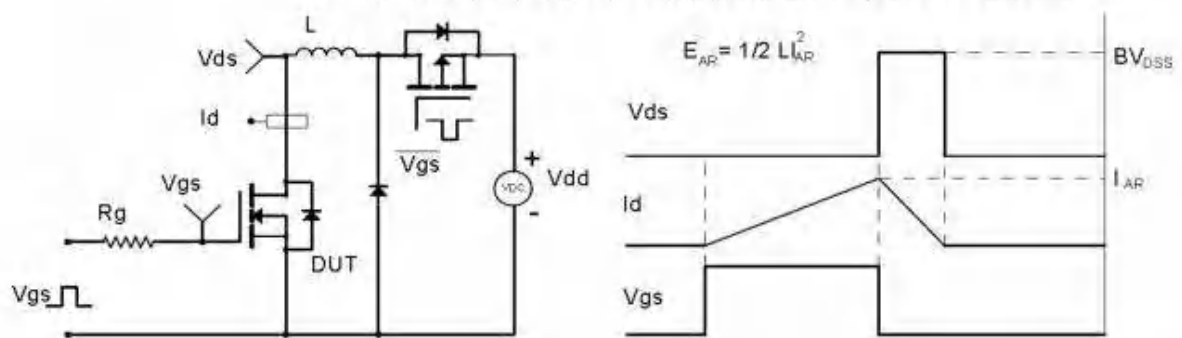

Diode Recovery Test Circuit & Waveforms

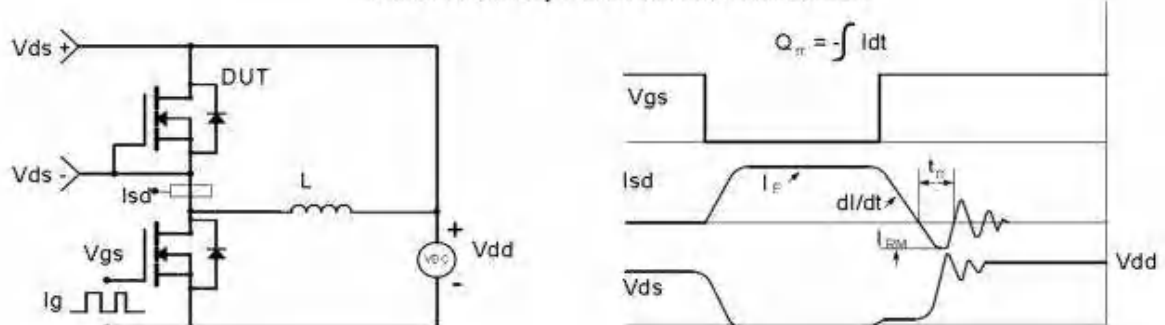

Typical Performance Characteristics

Fig.1 Power Dissipation Derating Curve

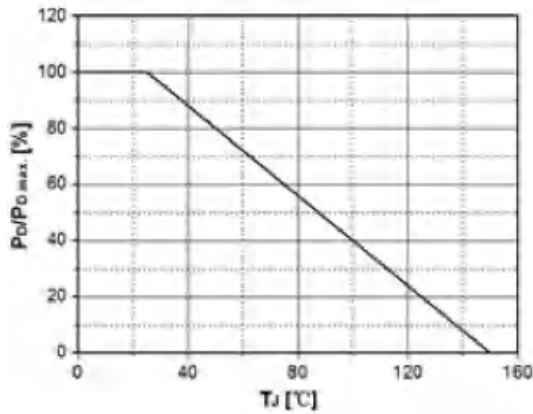

Fig.2 Avalanche Energy Derating Curve vs. Junction Temperature

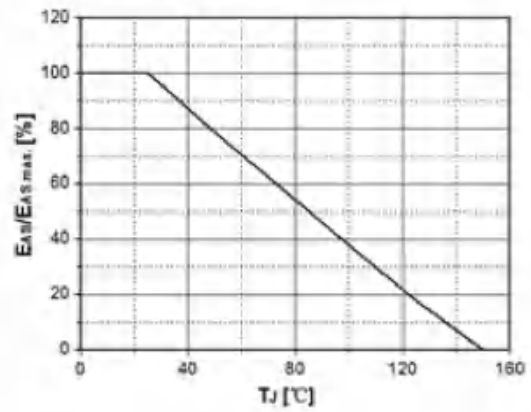

Fig.3 Typical Output Characteristics

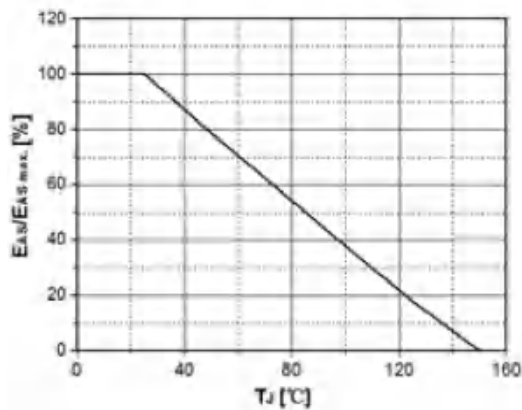

Fig. 4 Transconductance vs. Drain Current

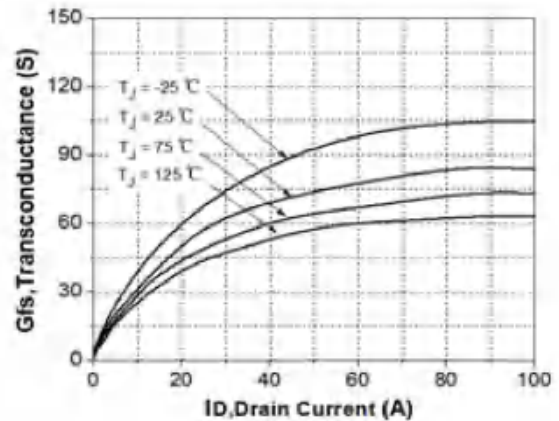

Fig.5 Typical Transfer Characteristics

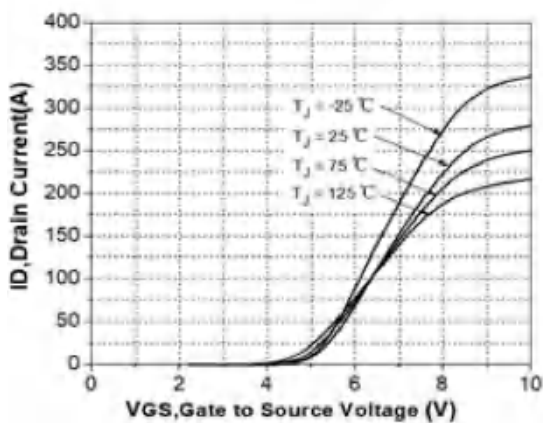

Fig. 6 State Resistance vs. Drain Current @-25°C

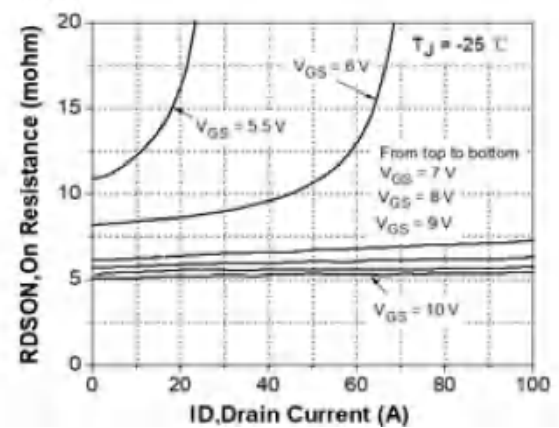

Fig.7 State Resistance vs. Drain Current @25°C

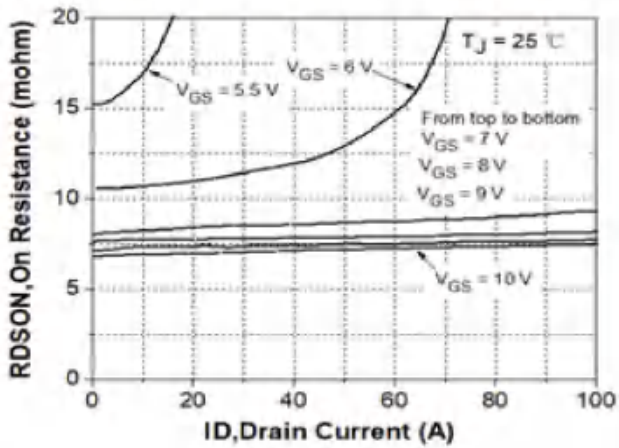

Fig. 8 State Resistance vs. Drain Current @125°C

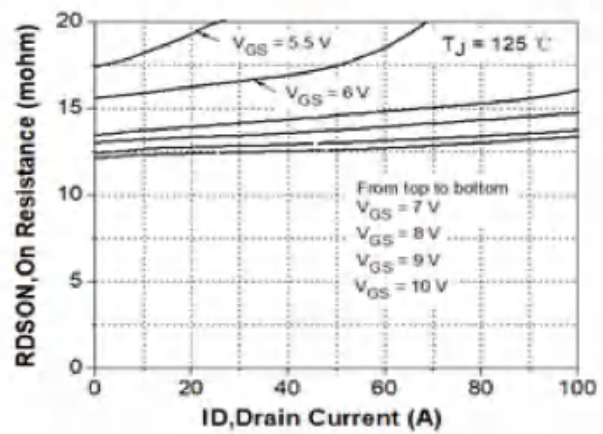

Fig.9 Typical Capacitance vs. Drain Source Voltage

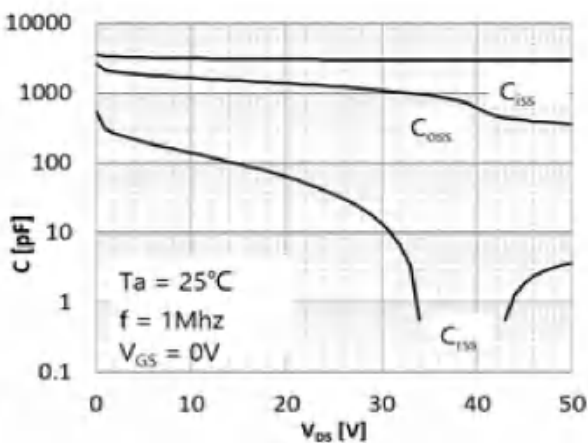

Fig.10 Dynamic Input Characteristics

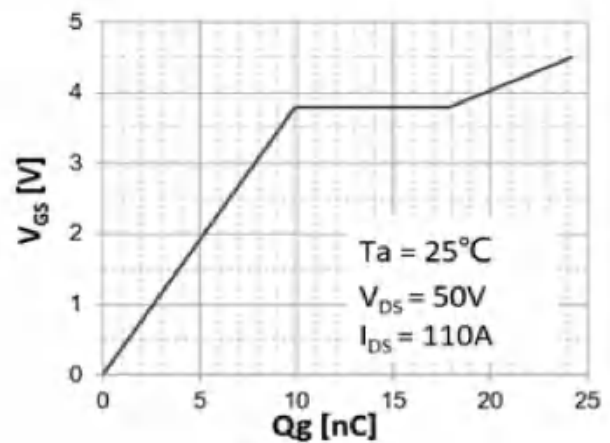

Fig.11 Breakdown Voltage vs. Junction Temperature

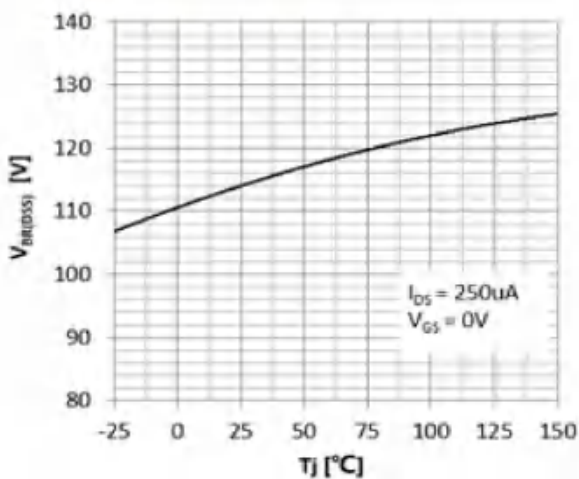

Fig. 12 Gate Threshold Voltage vs. Junction Temperature

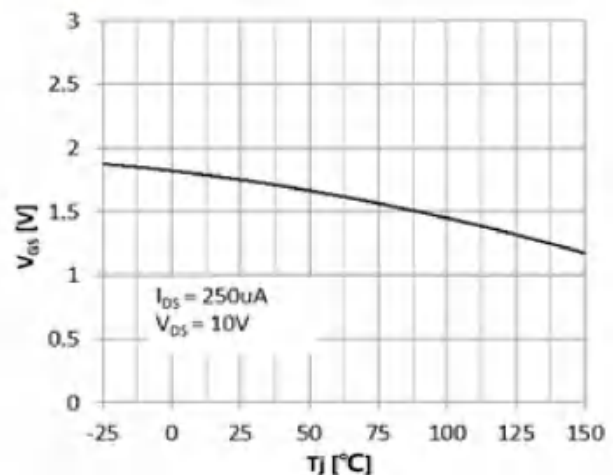

Fig.13 Safe Operating Area

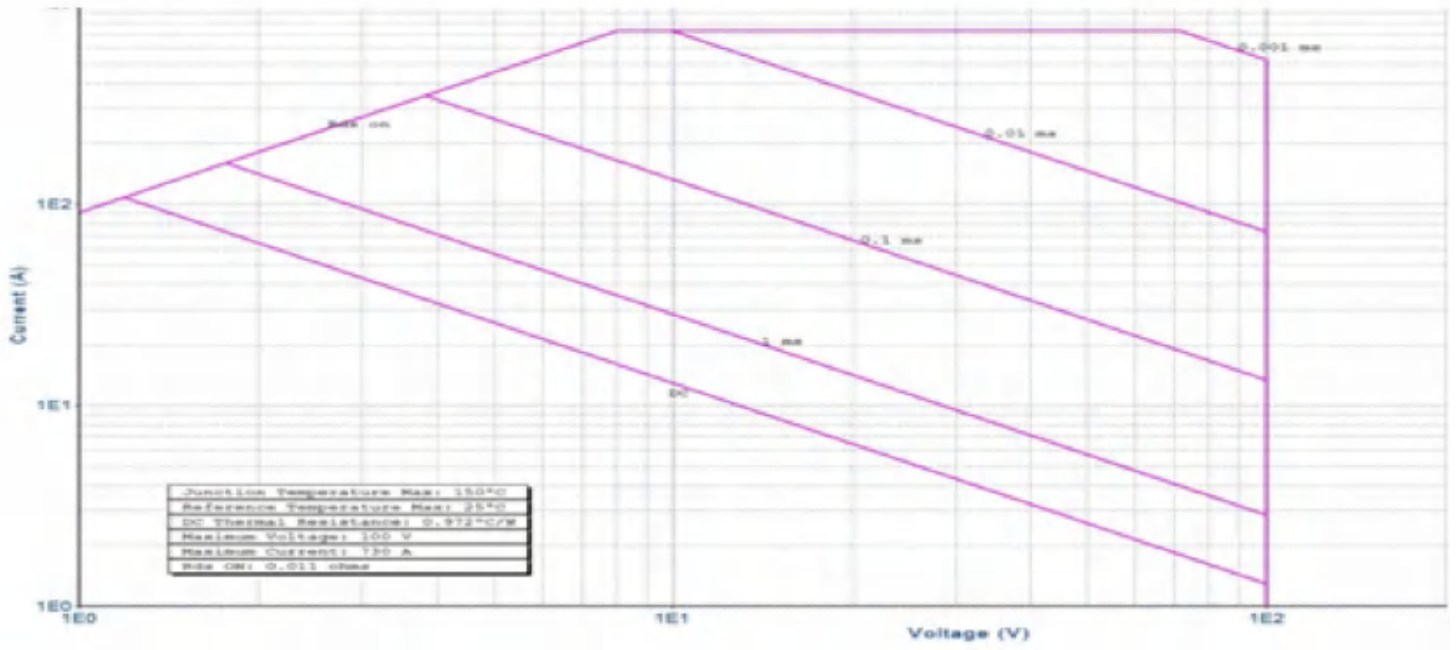
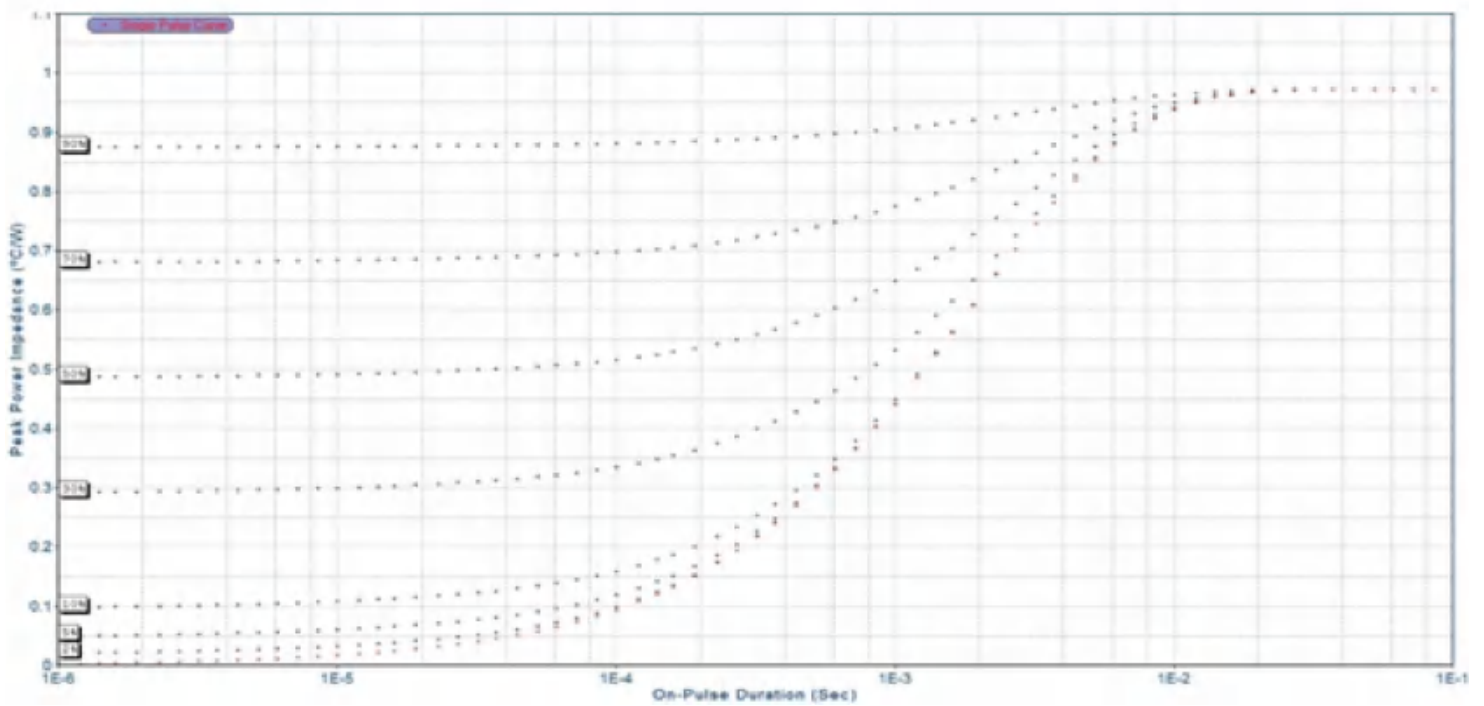
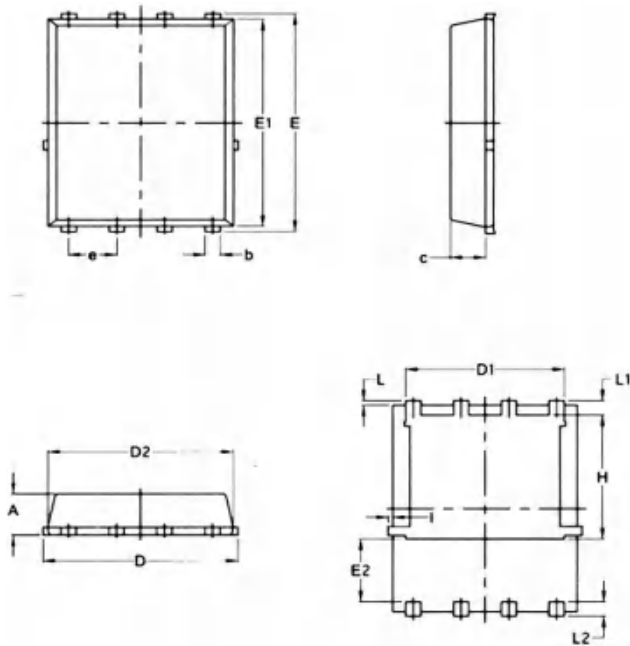

Fig. 14 Transient Thermal Response Curve



PDFN5*6-8L Package Information



PDFN5X6-8L

SYMBOL	COMMON			
	MM		INCH	
	MIN.	MAX.	MIN.	MAX.
A	1.03	1.17	0.0406	0.0461
b	0.34	0.48	0.0134	0.0189
c	0.824	0.970	0.0324	0.0382
D	4.80	5.40	0.1890	0.2126
D1	4.11	4.31	0.1618	0.1697
D2	4.80	5.00	0.1890	0.1969
E	5.95	6.15	0.2343	0.2421
E1	5.65	5.85	0.2224	0.2303
E2	1.60	—	0.0630	—
e	1.27 BSC		0.05 BSC	
L	0.05	0.25	0.0020	0.0098
L1	0.38	0.50	0.0150	0.0197
L2	0.38	0.50	0.0150	0.0197
H	3.30	3.50	0.1299	0.1378
I	—	0.18	—	0.0070