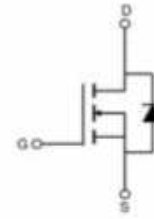


# AP4013S

## N-Channel Power Mosfet

### Feature

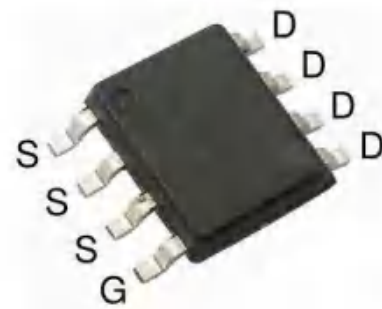
- 40V,10A  
 $R_{DS(ON)} < 22m\Omega @ V_{GS}=10V$   
 $R_{DS(ON)} < 30m\Omega @ V_{GS}=4.5V$
- Trench DMOS Power MOSFET
- Fast Switching
- Exceptional on-resistance and maximum DC current capability



Schematic Diagram

### Application

- DC/DC Converter
- Load Switch for Portable Devices
- Battery Switch



SOP-8

### Package Marking and Ordering Information

Device Marking	Device	Device Package	Reel Size	Tape width	Quantity (PCS)
4013S	AP4013S	SOP-8	13 inch	-	4000

### ABSOLUTE MAXIMUM RATINGS ( $T_a=25^{\circ}C$ unless otherwise noted)

Parameter	Symbol	Value	Unit
Drain-Source Voltage	$V_{DS}$	40	V
Gate-Source Voltage	$V_{GS}$	$\pm 20$	V
Continuous Drain Current ( $T_a=25^{\circ}C$ )	$I_D$	10	A
Continuous Drain Current ( $T_a=100^{\circ}C$ )	$I_D$	6.5	A
Pulsed Drain Current <sup>(1)</sup>	$I_{DM}$	40	A
Power Dissipation	$P_D$	2	W
Thermal Resistance from Junction to Ambient	$R_{\theta JA}$	62.5	$^{\circ}C/W$
Junction Temperature	$T_J$	150	$^{\circ}C$
Storage Temperature	$T_{STG}$	-55~ +150	$^{\circ}C$

# AP4013S

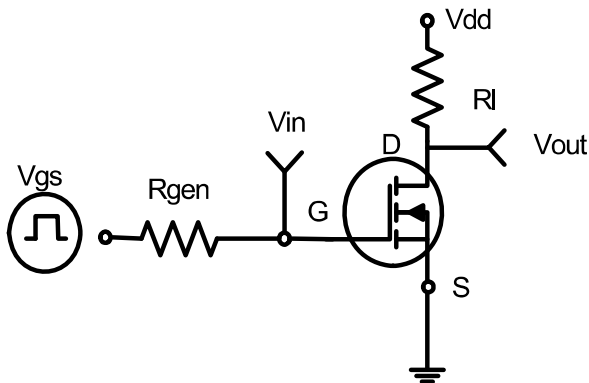
## N-Channel Power Mosfet

### MOSFET ELECTRICAL CHARACTERISTICS( $T_a=25^{\circ}\text{C}$ unless otherwise noted)

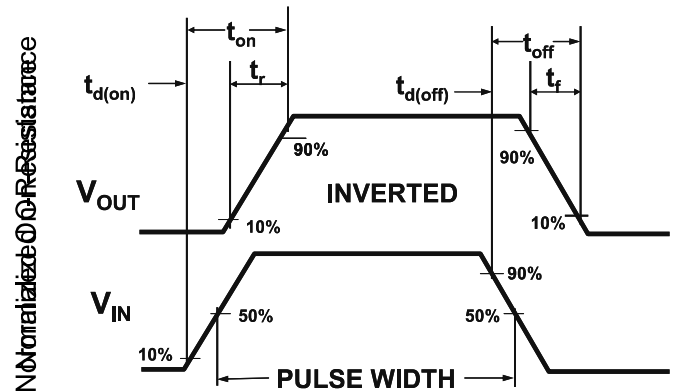
Parameter	Symbol	Test Condition	Min	Type	Max	Unit
<b>Static Characteristics</b>						
Drain-source breakdown voltage	$V_{(BR)DSS}$	$V_{GS} = 0V, I_D = 250\mu A$	40	-	-	V
Zero gate voltage drain current	$I_{DSS}$	$V_{DS} = 40V, V_{GS} = 0V$	-	-	1	$\mu A$
Gate-body leakage current	$I_{GSS}$	$V_{GS} = \pm 20V, V_{DS} = 0V$	-	-	$\pm 100$	nA
Gate threshold voltage <sup>(2)</sup>	$V_{GS(th)}$	$V_{DS} = V_{GS}, I_D = 250\mu A$	1	1.5	2.5	V
Drain-source on-resistance <sup>(2)</sup>	$R_{DS(on)}$	$V_{GS} = 10V, I_D = 10A$	-	17	22	m $\Omega$
		$V_{GS} = 4.5V, I_D = 6A$	-	22	30	
<b>Dynamic characteristics</b>						
Input Capacitance	$C_{iss}$	$V_{DS} = 20V, V_{GS} = 0V, f = 1MHz$	-	1050	-	pF
Output Capacitance	$C_{oss}$		-	84	-	
Reverse Transfer Capacitance	$C_{rss}$		-	72	-	
<b>Switching characteristics</b>						
Turn-on delay time	$t_{d(on)}$	$V_{DD} = 20V, R_L = 1.5\Omega$ $V_{GS} = 10V, R_G = 3\Omega$	-	11	-	ns
Turn-on rise time	$t_r$		-	13	-	
Turn-off delay time	$t_{d(off)}$		-	36	-	
Turn-off fall time	$t_f$		-	9	-	
Total Gate Charge	$Q_g$	$V_{DS} = 20V, I_D = 5A,$ $V_{GS} = 10V$	-	11	-	nC
Gate-Source Charge	$Q_{gs}$		-	1.9	-	
Gate-Drain Charge	$Q_{gd}$		-	2.2	-	
<b>Source-Drain Diode characteristics</b>						
Diode Forward voltage <sup>(2)</sup>	$V_{DS}$	$V_{GS} = 0V, I_S = 10A$	-	-	1.2	V
Diode Forward current <sup>(3)</sup>	$I_S$		-	-	40	A

#### Notes:

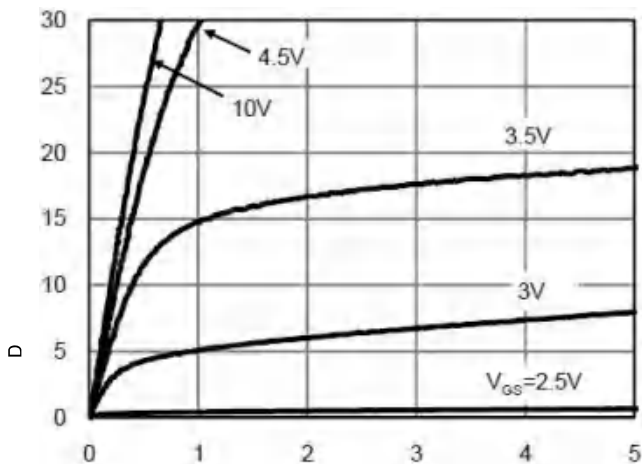
1. Repetitive Rating: pulse width limited by maximum junction temperature
2. Pulse Test: pulse width  $\leq 300\mu s$ , duty cycle  $\leq 2\%$
3. Surface Mounted on FR4 Board,  $t_s \leq 10$  sec



**Figure 1: Switching Test Circuit**

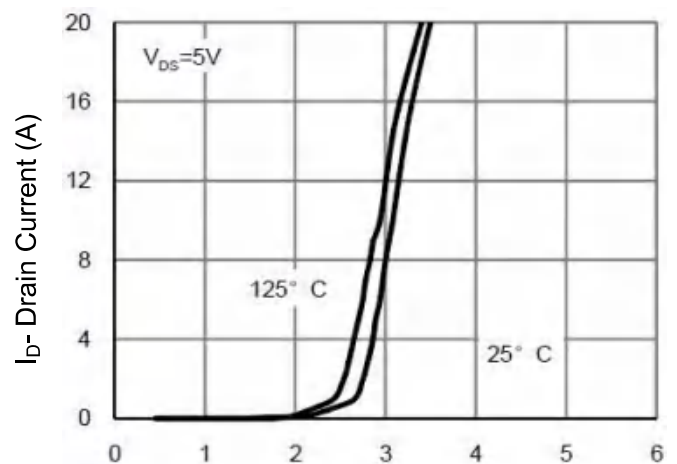


**Figure 2: Switching Waveforms**



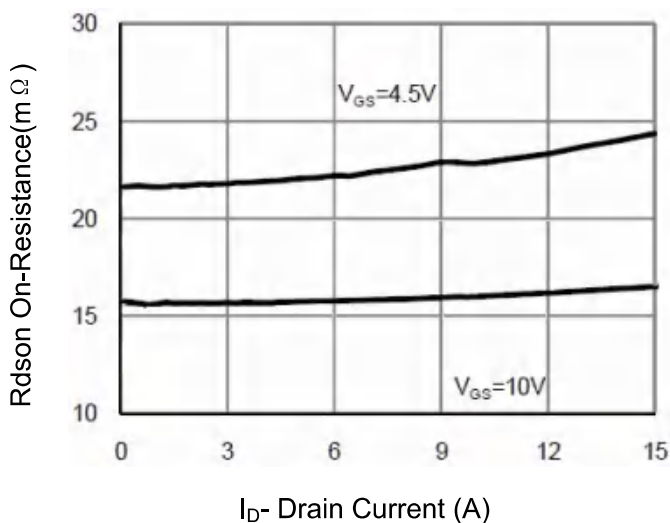
Vds Drain-Source Voltage (V)

**Figure 3 Output Characteristics**



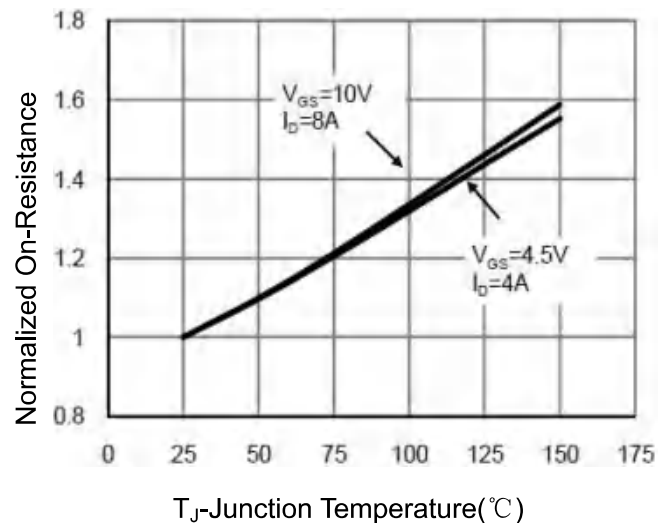
Vgs Gate-Source Voltage (V)

**Figure 4 Transfer Characteristics**



ID- Drain Current (A)

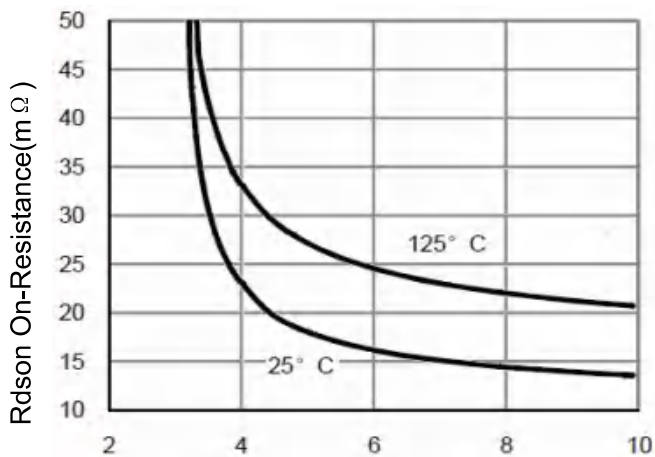
**Figure 5 Drain-Source On-Resistance**



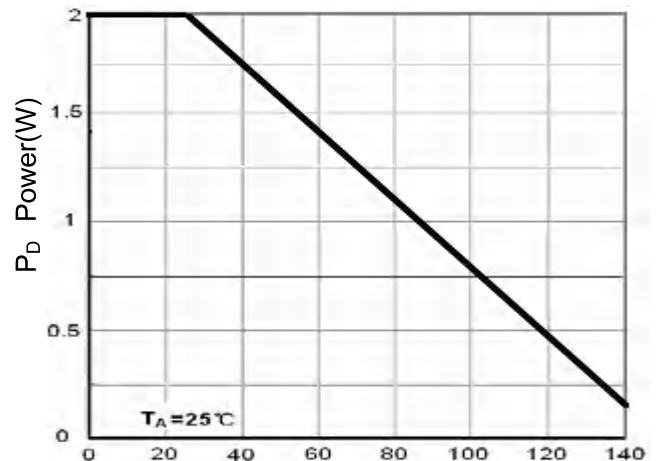
TJ-Junction Temperature(°C)

**Figure 6 Drain-Source On-Resistance**

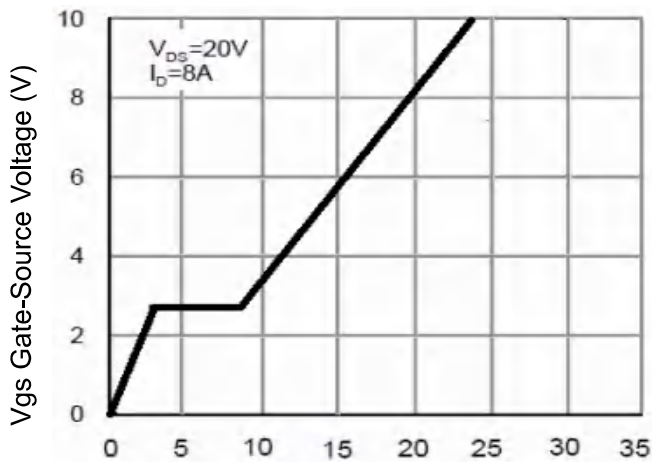
**AP4013S**  
N-Channel Power Mosfet



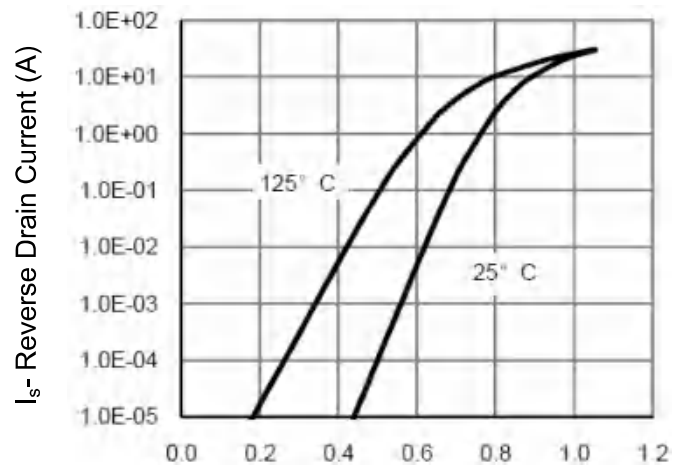
Vgs Gate-Source Voltage (V)  
**Figure 7 Rdson vs Vgs**



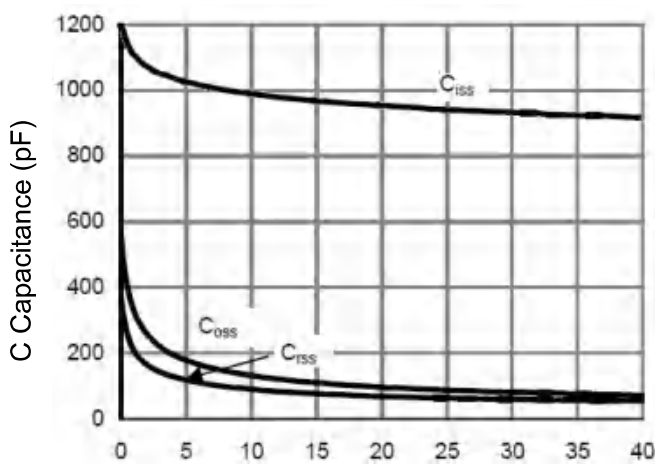
Tj Junction Temperature (°C)  
**Figure 8 Power Dissipation**



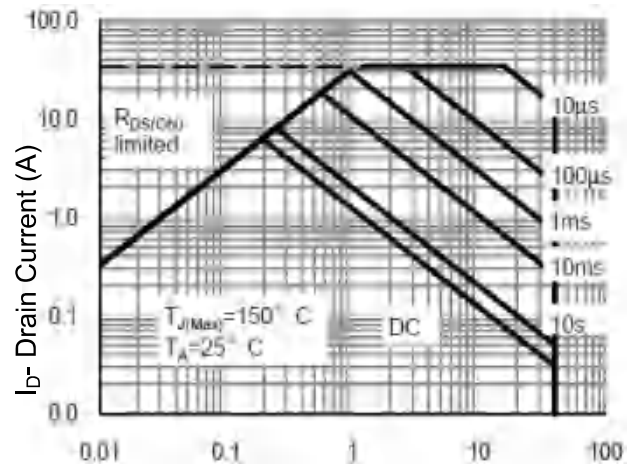
Qg Gate Charge (nC)  
**Figure 9 Gate Charge**



Vds Drain-Source Voltage (V)  
**Figure 10 Source- Drain Diode Forward**

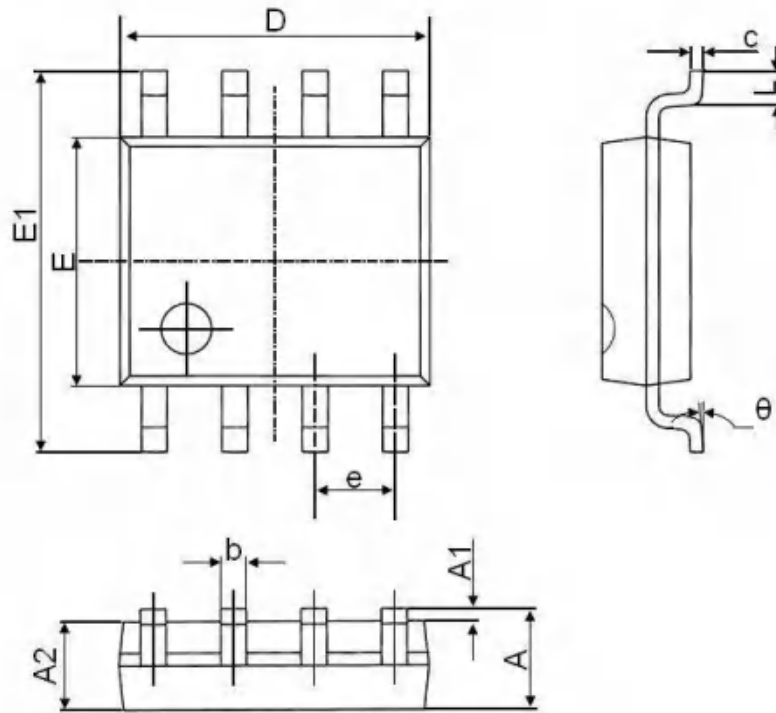


Vds Drain-Source Voltage (V)  
**Figure 11 Capacitance vs Vds**



Vds Drain-Source Voltage (V)  
**Figure 12 Safe Operation Area**

**SOP-8 Package Information**



Symbol	Dimensions In Millimeters		Dimensions In Inches	
	Min.	Max.	Min.	Max.
A	1.350	1.750	0.053	0.069
A1	0.100	0.250	0.004	0.010
A2	1.350	1.550	0.053	0.061
b	0.330	0.510	0.013	0.020
c	0.170	0.250	0.006	0.010
D	4.700	5.100	0.185	0.200
E	3.800	4.000	0.150	0.157
E1	5.800	6.200	0.228	0.244
e	1.270(BSC)		0.050(BSC)	
L	0.400	1.270	0.016	0.050
θ	0°	8°	0°	8°