



# 100V 6.0mΩ N-Ch Power MOSFET

### Features

- Ultra-low ON-resistance,  $R_{DS(ON)}$
- Low Gate Charge,  $Q_g$
- 100% UIS and  $R_g$  Tested
- Pb-free Lead Plating
- Halogen-free and RoHS-compliant
- AEC-Q101 Qualified for Automotive Applications

### Product Summary

| Parameter                                | Value | Unit |
|--|-------|------|
| $V_{DS}$                                 | 100   | V    |
| $V_{GS(th\_Typ)}$                        | 1.8   | V    |
| $I_D$ (@ $V_{GS} = 10V$ ) <sup>(1)</sup> | 88    | A    |
| $R_{DS(ON\_Typ)}$ (@ $V_{GS} = 10V$ )    | 6.0   | mΩ   |
| $R_{DS(ON\_Typ)}$ (@ $V_{GS} = 4.5V$ )   | 8.0   | mΩ   |

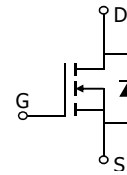
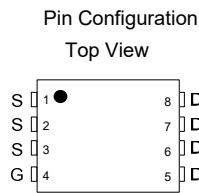
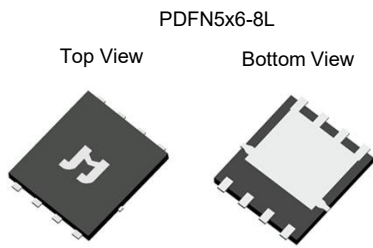

### Ordering Information

| Device         | Package    | # of Pins | Marking  | MSL | $T_J$ (°C) | Media        | Quantity (pcs) |
|----------------|------------|-----------|----------|-----|------------|--------------|----------------|
| JMSL1008AGQ-13 | PDFN5x6-8L | 8         | SL1008AQ | 1   | -55 to 175 | 13-inch Reel | 5000           |

### Absolute Maximum Ratings (@ $T_A = 25^\circ C$ unless otherwise specified)

| Parameter                               | Symbol         | Value               | Unit |
|---|----------------|---------------------|------|
| Drain-to-Source Voltage                 | $V_{DS}$       | 100                 | V    |
| Gate-to-Source Voltage                  | $V_{GS}$       | $\pm 20$            | V    |
| Continuous Drain Current <sup>(1)</sup> | $I_D$          | $T_C = 25^\circ C$  | 88   |
|   |                | $T_C = 100^\circ C$ | 62   |
| Pulsed Drain Current <sup>(2)</sup>     | $I_{DM}$       | 351                 | A    |
| Avalanche Current <sup>(3)</sup>        | $I_{AS}$       | 28                  | A    |
| Avalanche Energy <sup>(3)</sup>         | $E_{AS}$       | 118                 | mJ   |
| Power Dissipation <sup>(4)</sup>        | $P_D$          | $T_C = 25^\circ C$  | 125  |
|   |                | $T_C = 100^\circ C$ | 63   |
| Junction & Storage Temperature Range    | $T_J, T_{STG}$ | -55 to 175          | °C   |

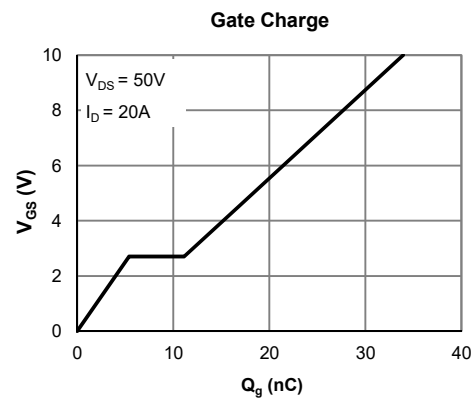
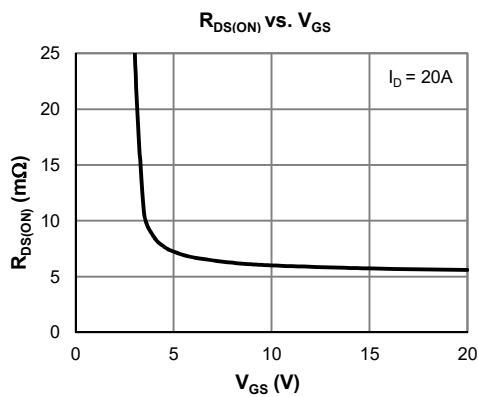



**Electrical Characteristics** (@  $T_J = 25^\circ\text{C}$  unless otherwise specified)

| Parameter                                     | Symbol        | Conditions   | Min.  | Typ. | Max.       | Unit             |
|---|---------------|--|---|------|------------|------------------|
| <b>STATIC PARAMETERS</b>                      |               |  |   |      |            |                  |
| Drain-Source Breakdown Voltage                | $V_{(BR)DSS}$ | $I_D = 250\mu\text{A}, V_{GS} = 0\text{V}$   | 100   |      |            | V                |
| Zero Gate Voltage Drain Current               | $I_{DSS}$     | $V_{DS} = 80\text{V}, V_{GS} = 0\text{V}$<br>$T_J = 55^\circ\text{C}$              |   |      | 1.0<br>5.0 | $\mu\text{A}$    |
| Gate-Body Leakage Current                     | $I_{GSS}$     | $V_{DS} = 0\text{V}, V_{GS} = \pm 20\text{V}$                                      |   |      | $\pm 100$  | nA               |
| Gate Threshold Voltage                        | $V_{GS(th)}$  | $V_{DS} = V_{GS}, I_D = 250\mu\text{A}$  | 1.2   | 1.8  | 2.5        | V                |
| Static Drain-Source ON-Resistance             | $R_{DS(on)}$  | $V_{GS} = 10\text{V}, I_D = 20\text{A}$  |   | 6.0  | 7.6        | $\text{m}\Omega$ |
|   |               | $V_{GS} = 4.5\text{V}, I_D = 15\text{A}$   |   | 8.0  | 10.0       | $\text{m}\Omega$ |
| Forward Transconductance                      | $g_{FS}$      | $V_{DS} = 5\text{V}, I_D = 20\text{A}$   |   | 82   |            | S                |
| Diode Forward Voltage                         | $V_{SD}$      | $I_S = 1\text{A}, V_{GS} = 0\text{V}$  |   | 0.72 | 1.0        | V                |
| Diode Continuous Current                      | $I_S$         | $T_C = 25^\circ\text{C}$   |   |      | 125        | A                |
| <b>DYNAMIC PARAMETERS</b> <sup>(5)</sup>      |               |  |   |      |            |                  |
| Input Capacitance                             | $C_{iss}$     | $V_{GS} = 0\text{V}, V_{DS} = 50\text{V}, f = 1\text{MHz}$                         |   | 2200 |            | pF               |
| Output Capacitance                            | $C_{oss}$     |  |   | 445  |            | pF               |
| Reverse Transfer Capacitance                  | $C_{rss}$     |  |   | 8.0  |            | pF               |
| Gate Resistance                               | $R_g$         | $V_{GS} = 0\text{V}, V_{DS} = 0\text{V}, f = 1\text{MHz}$                          |   | 1.8  |            | $\Omega$         |
| <b>SWITCHING PARAMETERS</b> <sup>(5)</sup>    |               |  |   |      |            |                  |
| Total Gate Charge (@ $V_{GS} = 10\text{V}$ )  | $Q_g$         | $V_{GS} = 0 \text{ to } 10\text{V}$<br>$V_{DS} = 50\text{V}, I_D = 20\text{A}$     |   | 34   |            | nC               |
| Total Gate Charge (@ $V_{GS} = 4.5\text{V}$ ) | $Q_g$         |  |   | 17.0 |            | nC               |
| Gate Source Charge                            | $Q_{gs}$      |  |   | 5.5  |            | nC               |
| Gate Drain Charge                             | $Q_{gd}$      |  |   | 5.7  |            | nC               |
| Turn-On Delay Time                            | $t_{D(on)}$   | $V_{GS} = 10\text{V}, V_{DS} = 50\text{V}$<br>$R_L = 2.5\Omega, R_{GEN} = 6\Omega$ |   | 13.0 |            | ns               |
| Turn-On Rise Time                             | $t_r$         |  |   | 14.0 |            | ns               |
| Turn-Off Delay Time                           | $t_{D(off)}$  |  |   | 29   |            | ns               |
| Turn-Off Fall Time                            | $t_f$         |  |   | 17.0 |            | ns               |
| Body Diode Reverse Recovery Time              | $t_{rr}$      |  | $I_F = 15\text{A}, dI_F/dt = 100\text{A}/\mu\text{s}$ |      | 55         |                  |
| Body Diode Reverse Recovery Charge            | $Q_{rr}$      | $I_F = 15\text{A}, dI_F/dt = 100\text{A}/\mu\text{s}$                              |   | 90   |            | nC               |

**Thermal Performance**

| Parameter                               | Symbol          | Typ. | Max. | Unit                      |
|---|-----------------|------|------|---------------------------|
| Thermal Resistance, Junction-to-Ambient | $R_{\theta JA}$ | 48   | 58   | $^\circ\text{C}/\text{W}$ |
| Thermal Resistance, Junction-to-Case    | $R_{\theta JC}$ | 1.2  | 1.4  | $^\circ\text{C}/\text{W}$ |

**Notes:**

1. Computed continuous current assumes the condition of  $T_{J\_Max}$  while the actual continuous current depends on the thermal & electro-mechanical application board design.
2. This single-pulse measurement was taken under  $T_{J\_Max} = 175^\circ\text{C}$ .
3. This single-pulse measurement was taken under the following condition [L = 300 $\mu\text{H}$ ,  $V_{GS} = 10\text{V}$ ,  $V_{DS} = 50\text{V}$ ] while its value is limited by  $T_{J\_Max} = 175^\circ\text{C}$ .
4. The power dissipation  $P_D$  is based on  $T_{J\_Max} = 175^\circ\text{C}$ .
5. This value is guaranteed by design hence it is not included in the production test.

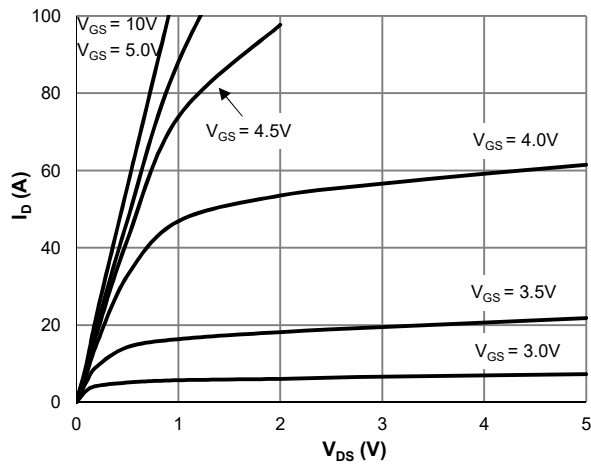
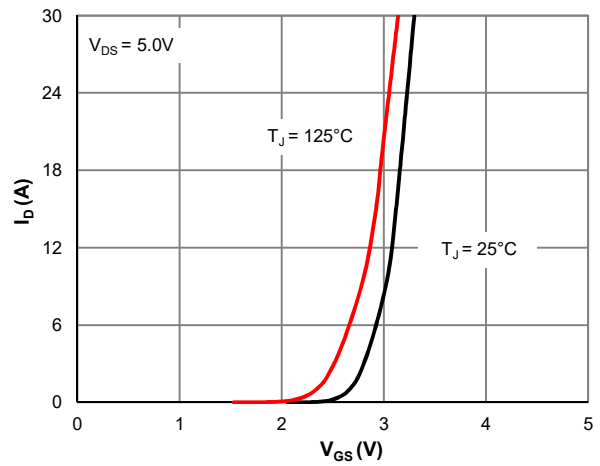
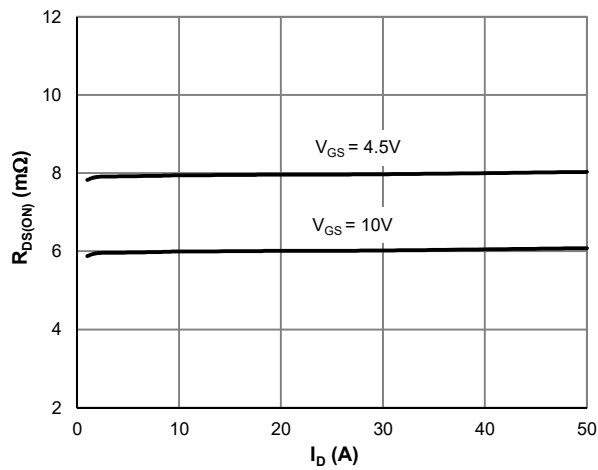
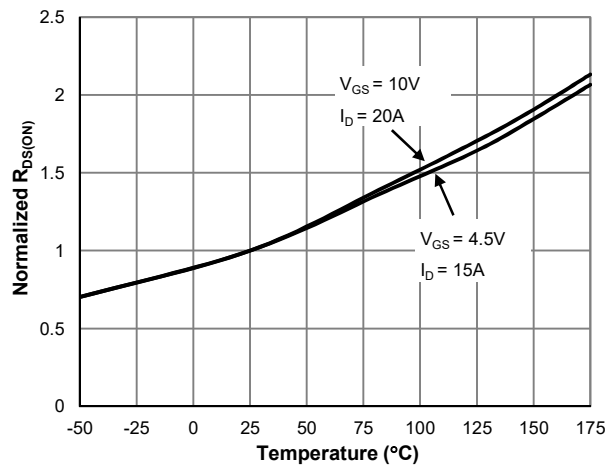
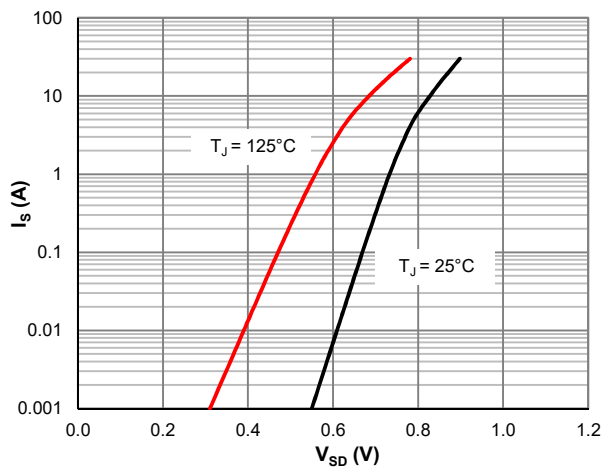
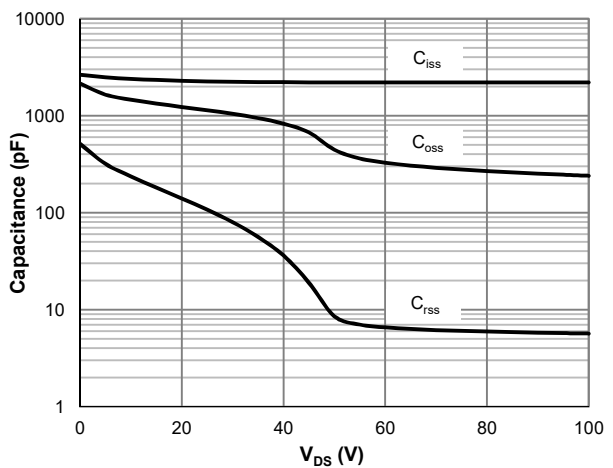
**Typical Electrical & Thermal Characteristics**

**Figure 1: Saturation Characteristics**

**Figure 2: Transfer Characteristics**

**Figure 3:  $R_{DS(ON)}$  vs. Drain Current**

**Figure 4:  $R_{DS(ON)}$  vs. Junction Temperature**

**Figure 5: Body-Diode Characteristics**

**Figure 6: Capacitance Characteristics**

Typical Electrical & Thermal Characteristics

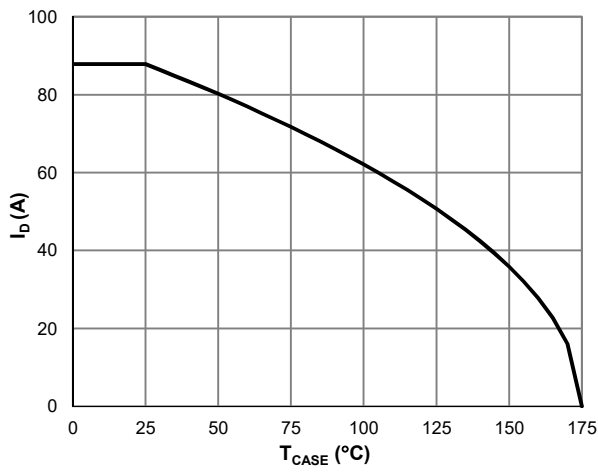

Figure 7: Current De-rating

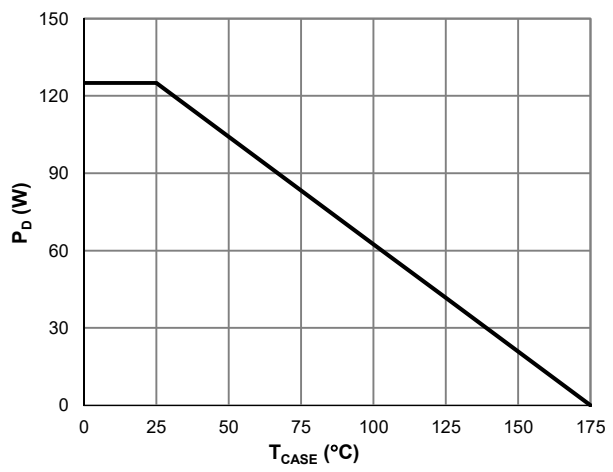

Figure 8: Power De-rating

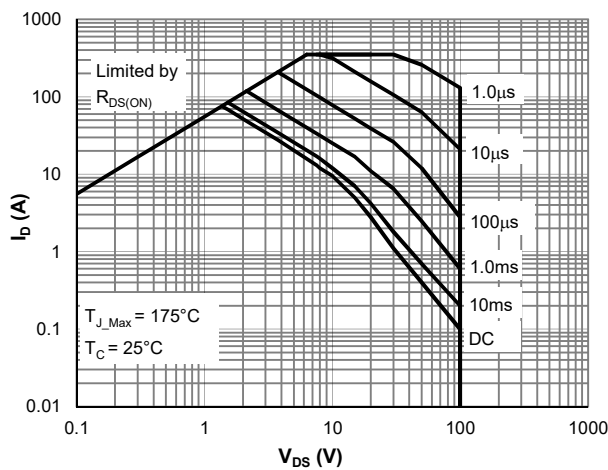

Figure 9: Maximum Safe Operating

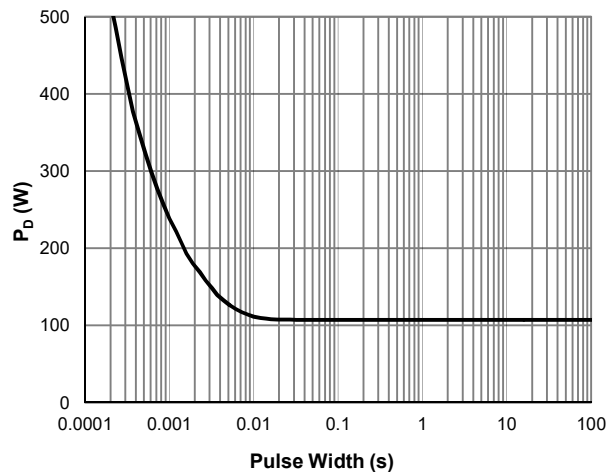

Figure 10: Single Pulse Power Rating, Junction-to-Case

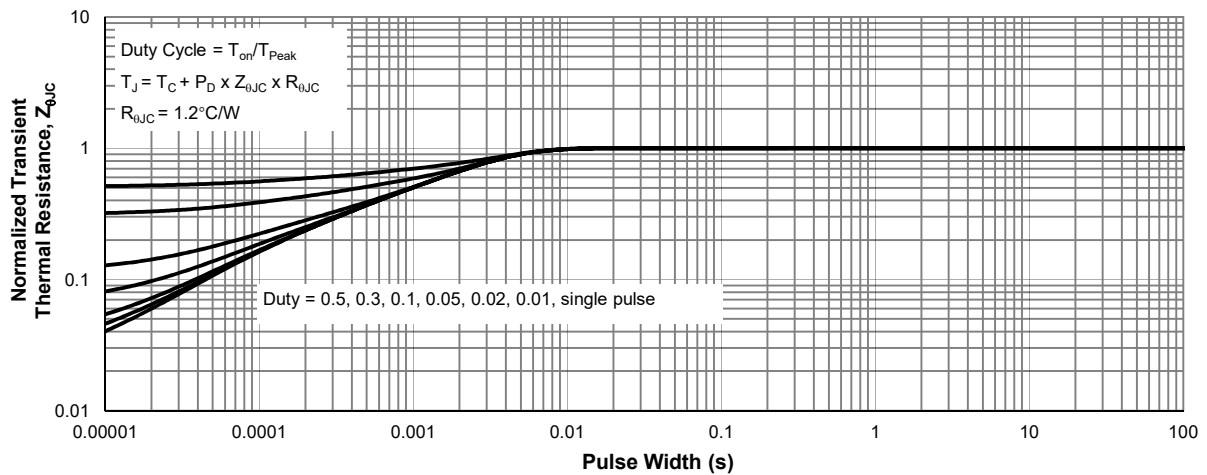
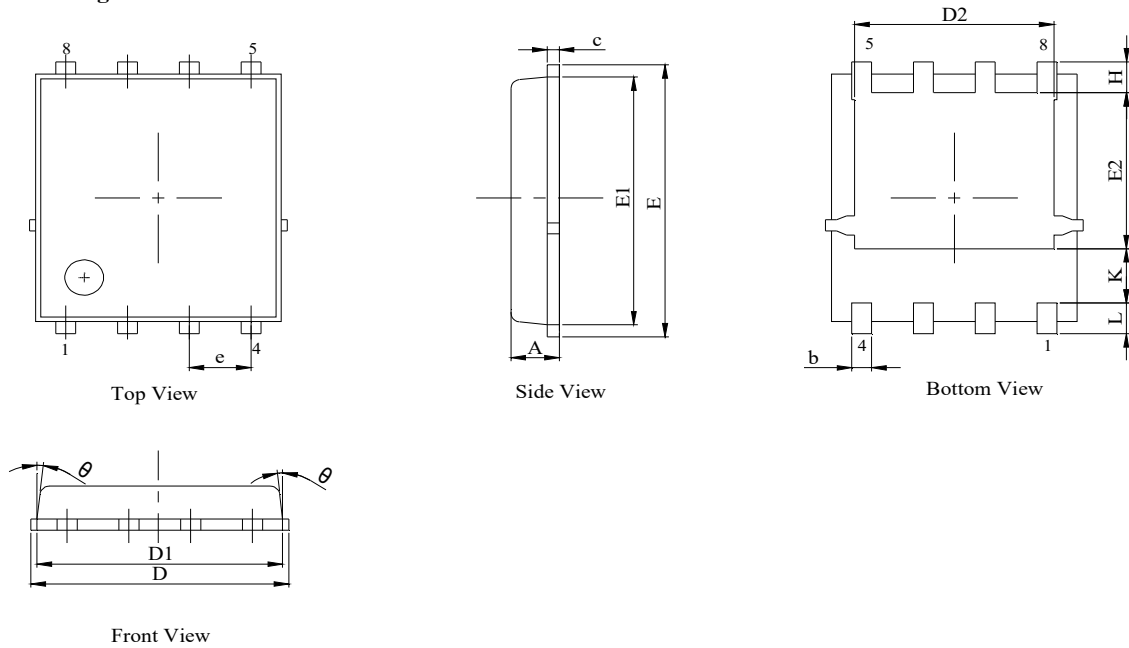
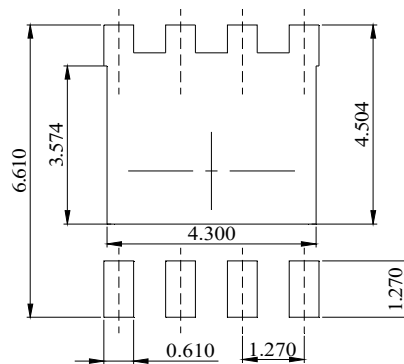

Figure 11: Normalized Maximum Transient Thermal Impedance

**PDFN5x6-8L Package Information**
**Package Outline**

**NOTES:**

1. Dimension and tolerance per ASME Y14.5M, 1994.
2. All dimensions in millimeter (angle in degree).
3. Dimensions D1 and E1 do not include mold flash protrusions or gate burrs.

| DIM.  | MILLIMETER |      |      |
|-------|------------|------|------|
|       | MIN.       | NOM. | MAX. |
| A     | 0.90       | 1.00 | 1.10 |
| b     | 0.31       | 0.41 | 0.51 |
| c     | 0.20       | 0.25 | 0.30 |
| D     | 5.00       | 5.20 | 5.40 |
| D1    | 4.95       | 5.05 | 5.15 |
| D2    | 4.00       | 4.10 | 4.20 |
| E     | 6.05       | 6.15 | 6.25 |
| E1    | 5.50       | 5.60 | 5.70 |
| E2    | 3.42       | 3.53 | 3.63 |
| e     | 1.27BSC    |      |      |
| H     | 0.60       | 0.70 | 0.80 |
| L     | 0.50       | 0.70 | 0.80 |
| theta | -          | -    | 10°  |

**Recommended Soldering Footprint**

DIMENSIONS: MILLIMETERS