



60V 8.5mΩ Dual N-Ch Power MOSFET

Features

- Ultra-low ON-resistance, $R_{DS(ON)}$
- Low Gate Charge, Q_g
- 100% UIS and R_g Tested
- Pb-free Lead Plating
- Halogen-free and RoHS-compliant
- AEC-Q101 Qualified for Automotive Applications

Product Summary

Parameter	Value	Unit
V_{DS}	60	V
$V_{GS(th_Typ)}$	1.6	V
I_D (@ $V_{GS} = 10V$) ⁽¹⁾	38	A
$R_{DS(ON_Typ)}$ (@ $V_{GS} = 10V$)	8.5	mΩ
$R_{DS(ON_Typ)}$ (@ $V_{GS} = 4.5V$)	10.2	mΩ

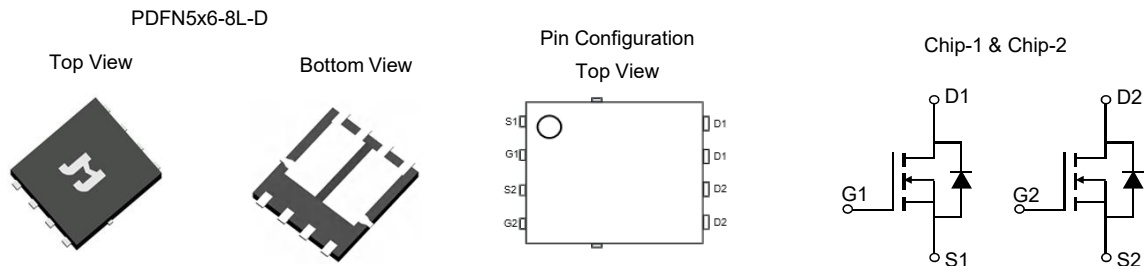

Ordering Information

Device	Package	# of Pins	Marking	MSL	T_J (°C)	Media	Quantity (pcs)
JMSL0610AGDQ-13	PDFN5x6-8L-D	8	L0610ADQ	1	-55 to 175	13-inch Reel	5000

Absolute Maximum Ratings (@ $T_A = 25^\circ C$ unless otherwise specified)

Parameter	Symbol	Value	Unit
Drain-to-Source Voltage	V_{DS}	60	V
Gate-to-Source Voltage	V_{GS}	± 20	V
Continuous Drain Current ⁽¹⁾	I_D	$T_C = 25^\circ C$	38
		$T_C = 100^\circ C$	27
Pulsed Drain Current ⁽²⁾	I_{DM}	154	A
Avalanche Current ⁽³⁾	I_{AS}	26	A
Avalanche Energy ⁽³⁾	E_{AS}	34	mJ
Power Dissipation ⁽⁴⁾	P_D	$T_C = 25^\circ C$	31
		$T_C = 100^\circ C$	15
Junction & Storage Temperature Range	T_J, T_{STG}	-55 to 175	°C

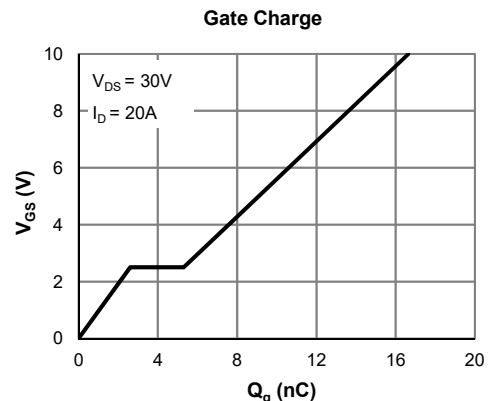
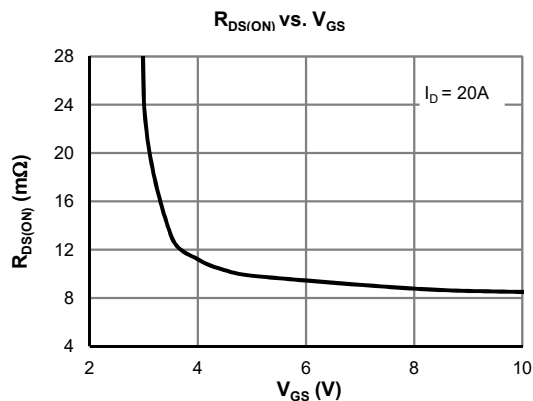

**Electrical Characteristics** (@ $T_J = 25^\circ\text{C}$ unless otherwise specified)

Parameter	Symbol	Conditions	Min.	Typ.	Max.	Unit
STATIC PARAMETERS						
Drain-Source Breakdown Voltage	$V_{(BR)DSS}$	$I_D = 250\mu\text{A}$, $V_{GS} = 0\text{V}$	60			V
Zero Gate Voltage Drain Current	I_{DSS}	$V_{DS} = 48\text{V}$, $V_{GS} = 0\text{V}$ $T_J = 55^\circ\text{C}$			1.0 5.0	μA
Gate-Body Leakage Current	I_{GSS}	$V_{DS} = 0\text{V}$, $V_{GS} = \pm 20\text{V}$			± 100	nA
Gate Threshold Voltage	$V_{GS(th)}$	$V_{DS} = V_{GS}$, $I_D = 250\mu\text{A}$	1.2	1.6	2.5	V
Static Drain-Source ON-Resistance	$R_{DS(on)}$	$V_{GS} = 10\text{V}$, $I_D = 20\text{A}$		8.5	10.6	$\text{m}\Omega$
		$V_{GS} = 4.5\text{V}$, $I_D = 15\text{A}$		10.2	13.0	$\text{m}\Omega$
Forward Transconductance	g_{FS}	$V_{DS} = 5\text{V}$, $I_D = 20\text{A}$		85		S
Diode Forward Voltage	V_{SD}	$I_S = 1\text{A}$, $V_{GS} = 0\text{V}$		0.69	1.0	V
Diode Continuous Current	I_S	$T_C = 25^\circ\text{C}$			31	A
DYNAMIC PARAMETERS ⁽⁵⁾						
Input Capacitance	C_{iss}	$V_{GS} = 0\text{V}$, $V_{DS} = 30\text{V}$, $f = 1\text{MHz}$		1087		pF
Output Capacitance	C_{oss}			309		pF
Reverse Transfer Capacitance	C_{rss}			8.5		pF
Gate Resistance	R_g	$V_{GS} = 0\text{V}$, $V_{DS} = 0\text{V}$, $f = 1\text{MHz}$		1.6		Ω
SWITCHING PARAMETERS ⁽⁵⁾						
Total Gate Charge (@ $V_{GS} = 10\text{V}$)	Q_g	$V_{GS} = 0$ to 10V $V_{DS} = 30\text{V}$, $I_D = 20\text{A}$		16.6		nC
Total Gate Charge (@ $V_{GS} = 4.5\text{V}$)	Q_g			8.3		nC
Gate Source Charge	Q_{gs}			2.6		nC
Gate Drain Charge	Q_{gd}			2.7		nC
Turn-On Delay Time	$t_{D(on)}$	$V_{GS} = 10\text{V}$, $V_{DS} = 30\text{V}$ $R_L = 1.5\Omega$, $R_{GEN} = 6\Omega$		4.7		ns
Turn-On Rise Time	t_r			7.6		ns
Turn-Off Delay Time	$t_{D(off)}$			24		ns
Turn-Off Fall Time	t_f			8.9		ns
Body Diode Reverse Recovery Time	t_{rr}		$I_F = 15\text{A}$, $dI_F/dt = 100\text{A}/\mu\text{s}$		26	
Body Diode Reverse Recovery Charge	Q_{rr}	$I_F = 15\text{A}$, $dI_F/dt = 100\text{A}/\mu\text{s}$		13.4		nC

Thermal Performance

Parameter	Symbol	Typ.	Max.	Unit
Thermal Resistance, Junction-to-Ambient	$R_{\theta JA}$	60	70	$^\circ\text{C}/\text{W}$
Thermal Resistance, Junction-to-Case	$R_{\theta JC}$	4.9	5.6	$^\circ\text{C}/\text{W}$

Notes:

1. Computed continuous current assumes the condition of T_{J_Max} while the actual continuous current depends on the thermal & electro-mechanical application board design.
2. This single-pulse measurement was taken under $T_{J_Max} = 175^\circ\text{C}$.
3. This single-pulse measurement was taken under the following condition [$L = 100\mu\text{H}$, $V_{GS} = 10\text{V}$, $V_{DD} = 30\text{V}$] while its value is limited by $T_{J_Max} = 175^\circ\text{C}$.
4. The power dissipation P_D is based on $T_{J_Max} = 175^\circ\text{C}$.
5. This value is guaranteed by design hence it is not included in the production test.



Typical Electrical & Thermal Characteristics

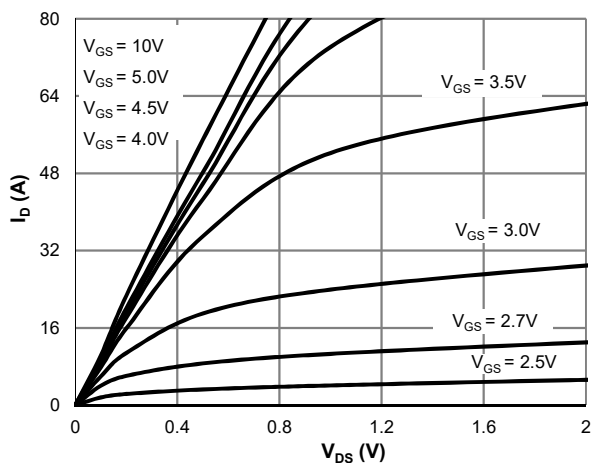

Figure 1: Saturation Characteristics

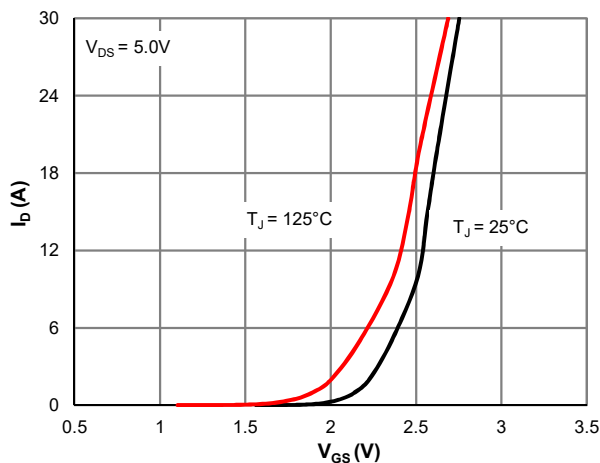

Figure 2: Transfer Characteristics

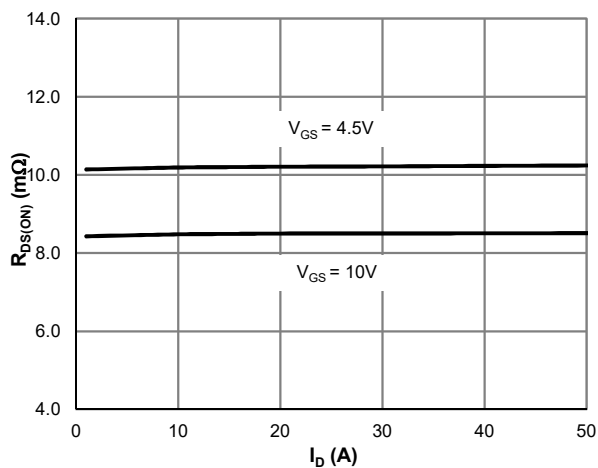

Figure 3: $R_{DS(ON)}$ vs. Drain Current

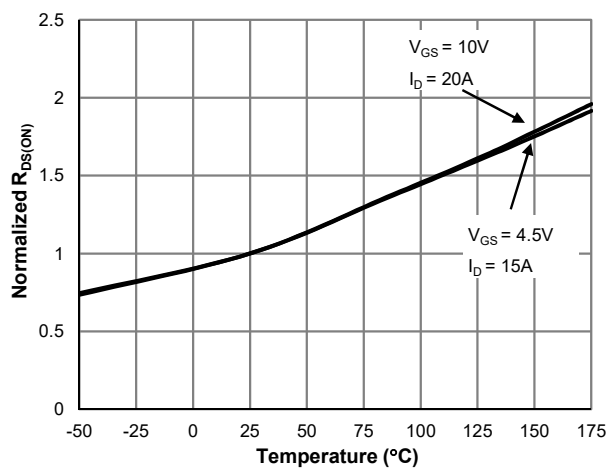

Figure 4: $R_{DS(ON)}$ vs. Junction Temperature

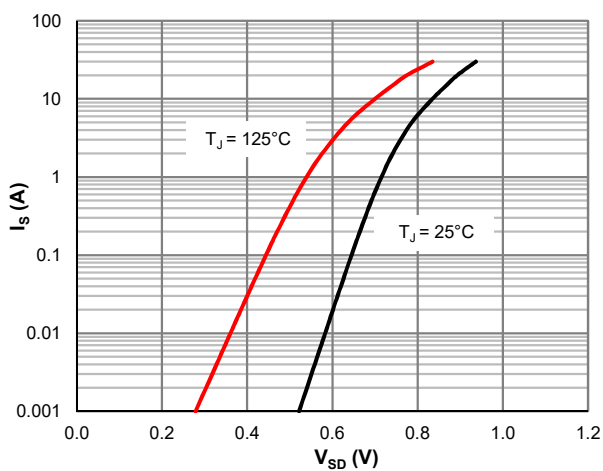

Figure 5: Body-Diode Characteristics

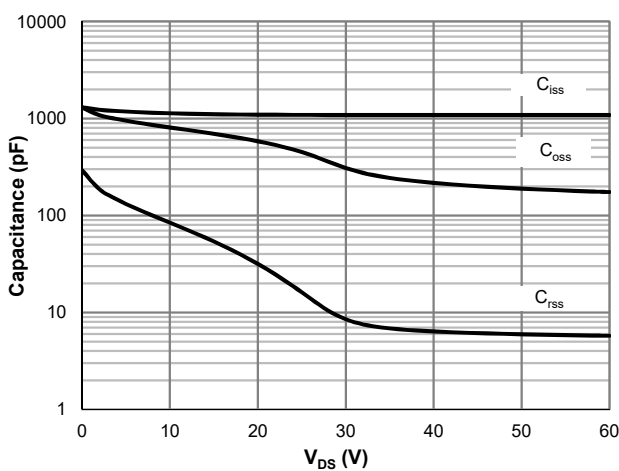

Figure 6: Capacitance Characteristics



Typical Electrical & Thermal Characteristics

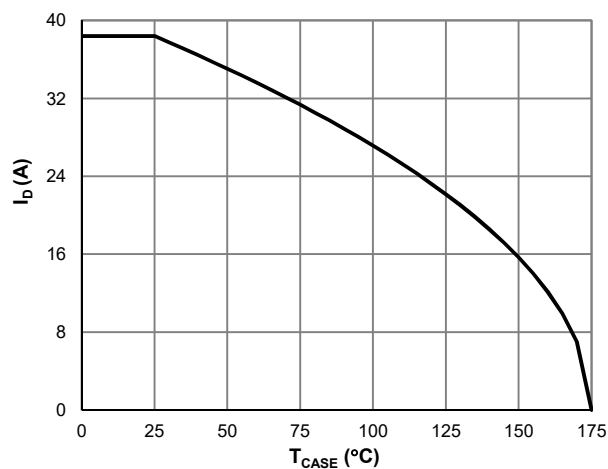

Figure 7: Current De-rating

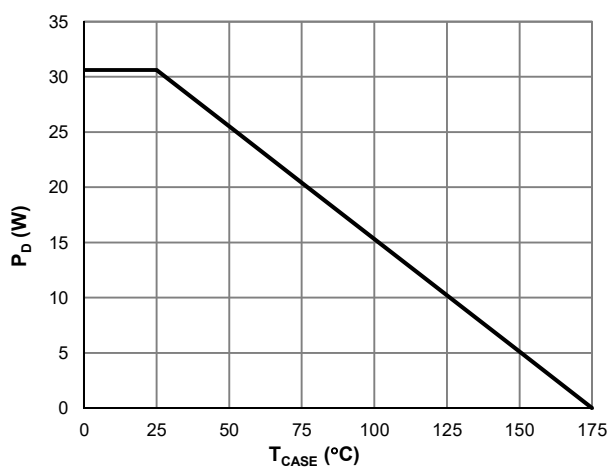

Figure 8: Power De-rating

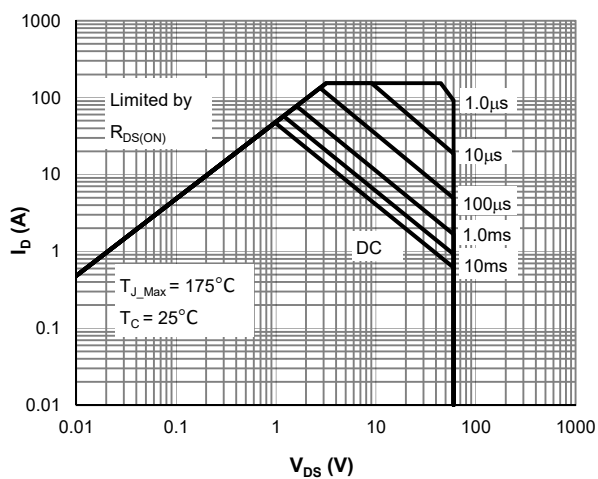

Figure 9: Maximum Safe Operating Area

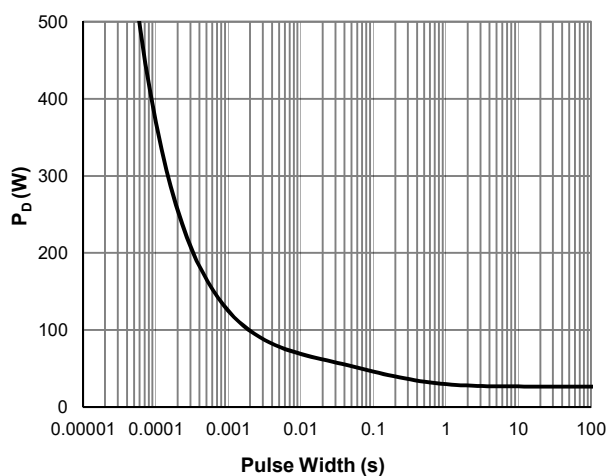

Figure 10: Single Pulse Power Rating, Junction-to-Case

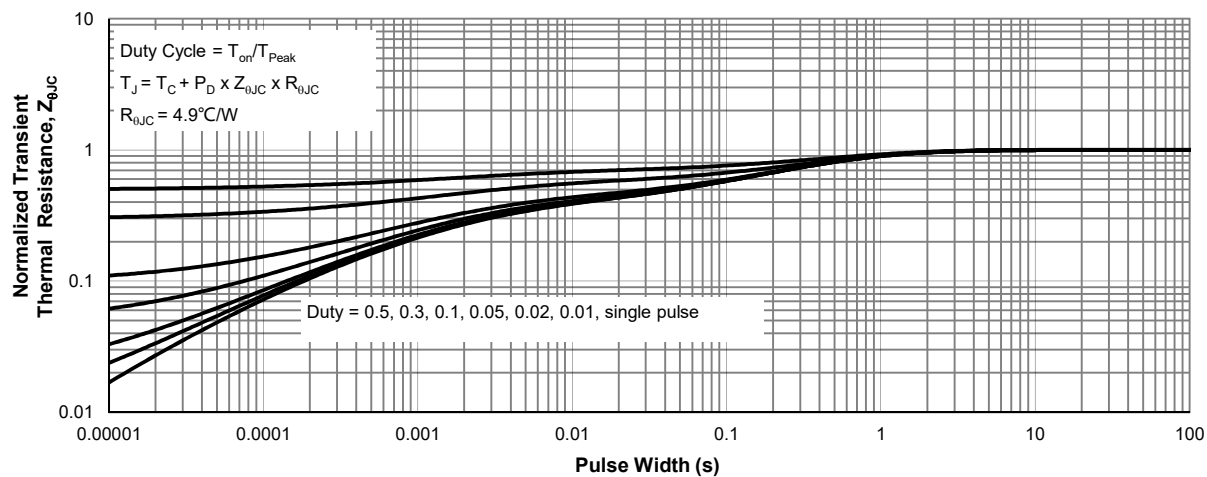
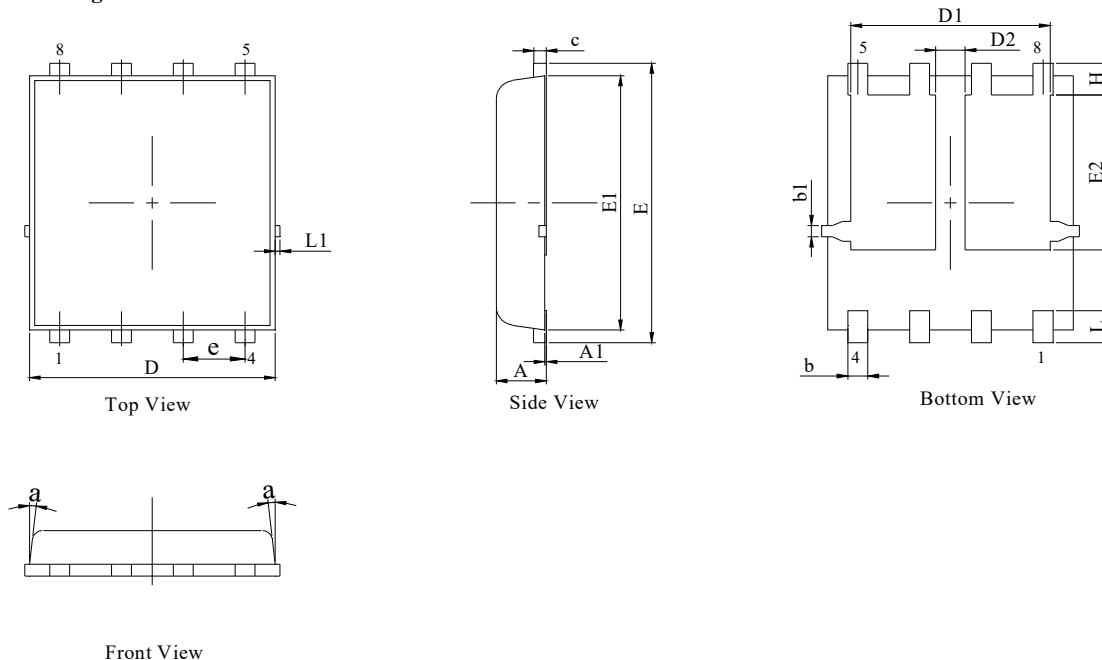
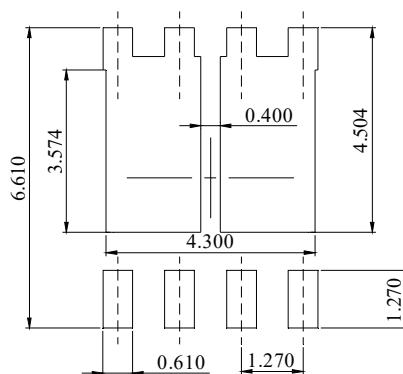

Figure 11: Normalized Maximum Transient Thermal Impedance

PDFN5x6-8L-D Package Information
Package Outline

NOTES:

1. DIMENSIONING AND TOLERANCING PER ASME Y14.5M,1994.
2. ALL DIMNESIONS IN MILLIMETER (ANNGL E IN DEGREE).
3. DIMENSIONS D1 AND E1 DO NOT INCLUDE MOLD FLASH PROTRUSIONS OR GATE BURRS.

DIM.	MILLIMETER		
	MIN.	NOM.	MAX.
A	0.90	1.00	1.10
A1	0.00	-	0.10
b	0.31	0.41	0.51
b1	0.15	0.25	0.35
c	0.23	-	0.33
D	4.95	5.05	5.15
D1	4.00	4.10	4.20
D2	0.50	0.60	0.70
E	6.05	6.15	6.25
E1	5.50	5.60	5.70
E2	3.31	3.41	3.51
e	1.27BSC		
H	0.60	0.70	0.80
L	0.50	0.70	0.80
L1	-	-	0.125
a	-	-	12°

Recommended Soldering Footprint

DIMENSIONS: MILLIMETERS