



Description

JMT N-channel Enhancement Mode Power MOSFET

Features

- 40V,40A
 $R_{DS(ON)} < 7.5m\Omega @ V_{GS} = 10V$
 $R_{DS(ON)} < 14m\Omega @ V_{GS} = 4.5V$
- Lead free and Green Device Available
- Excellent $R_{DS(ON)}$ and Low Gate Charge
- Lead free product is acquired

Application

- Load Switch
- PWM Application
- Power management



100% UIS TESTED!
100% ΔVds TESTED!

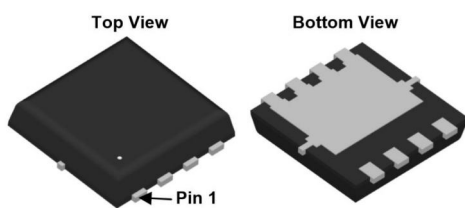

PDFN3x3-8L

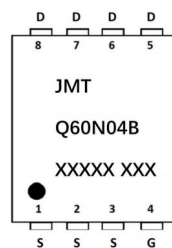

Marking and pin Assignment

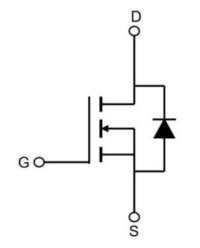

Schematic Diagram

Package Marking and Ordering Information

Device Marking	Device	OUTLINE	Device Package	Reel Size	Reel (PCS)	Per Carton (PCS)
JMTQ60N04B	JMTQ60N04B	TAPING	PDFN3x3-8L	13inch	5000	50000

Absolute Maximum Ratings (T_C=25°C unless otherwise specified)

Symbol	Parameter	Max.	Units
V _{DSS}	Drain-Source Voltage	40	V
V _{GSS}	Gate-Source Voltage	±20	V
I _D	Continuous Drain Current	T _C = 25°C	40
		T _C = 100°C	26
I _{DM}	Pulsed Drain Current ^{note1}	160	A
E _{AS}	Single Pulsed Avalanche Energy ^{note2}	56	mJ
P _D	Power Dissipation	T _C = 25°C	21
R _{θJC}	Thermal Resistance, Junction to Case	6	°C/W
T _J , T _{STG}	Operating and Storage Temperature Range	-55 to +150	°C



Electrical Characteristics (T_J=25°C unless otherwise specified)

Symbol	Parameter	Test Condition	Min.	Typ.	Max.	Units
Off Characteristic						
V _{(BR)DSS}	Drain-Source Breakdown Voltage	V _{GS} =0V, I _D =250μA	40	-	-	V
I _{DSS}	Zero Gate Voltage Drain Current	V _{DS} =40V, V _{GS} =0V,	-	-	1.0	μA
I _{GSS}	Gate to Body Leakage Current	V _{DS} =0V, V _{GS} =±20V	-	-	±100	nA
On Characteristics						
V _{GS(th)}	Gate Threshold Voltage	V _{DS} =V _{GS} , I _D =250μA	1.1	1.7	2.4	V
R _{DS(on)}	Static Drain-Source on-Resistance <small>note3</small>	V _{GS} =10V, I _D =30A	-	5.7	7.5	mΩ
		V _{GS} =4.5V, I _D =20A	-	10	14	
Dynamic Characteristics						
C _{iss}	Input Capacitance	V _{DS} =20V, V _{GS} =0V, f=1.0MHz	-	2400	-	pF
C _{oss}	Output Capacitance		-	192	-	pF
C _{rss}	Reverse Transfer Capacitance		-	165	-	pF
Q _g	Total Gate Charge	V _{DS} =20V, I _D =25A, V _{GS} =10V	-	45	-	nC
Q _{gs}	Gate-Source Charge		-	8	-	nC
Q _{gd}	Gate-Drain("Miller") Charge		-	10	-	nC
Switching Characteristics						
t _{d(on)}	Turn-on Delay Time	V _{DD} =30V, I _D =25A, R _L =1.2Ω, R _{GEN} =3Ω, V _{GS} =10V	-	12	-	ns
t _r	Turn-on Rise Time		-	75	-	ns
t _{d(off)}	Turn-off Delay Time		-	50	-	ns
t _f	Turn-off Fall Time		-	105	-	ns
Drain-Source Diode Characteristics and Maximum Ratings						
I _S	Maximum Continuous Drain to Source Diode Forward Current		-	-	40	A
I _{SM}	Maximum Pulsed Drain to Source Diode Forward Current		-	-	160	A
V _{SD}	Drain to Source Diode Forward Voltage	V _{GS} =0V, I _S =30A	-	-	1.2	V
t _{rr}	Body Diode Reverse Recovery Time	T _J =25°C, I _F =30A, dI/dt=100A/μs	-	15	-	ns
Q _{rr}	Body Diode Reverse Recovery Charge		-	8	-	nC

- Notes: 1. Repetitive Rating: Pulse Width Limited by Maximum Junction Temperature
 2. EAS condition: T_J=25°C, V_{DD}=20V, V_G=10V, R_G=25Ω, L=0.5mH, I_{AS}=15A
 3. Pulse Test: Pulse Width≤300μs, Duty Cycle≤0.5%



Typical Performance Characteristics

Figure 1: Output Characteristics

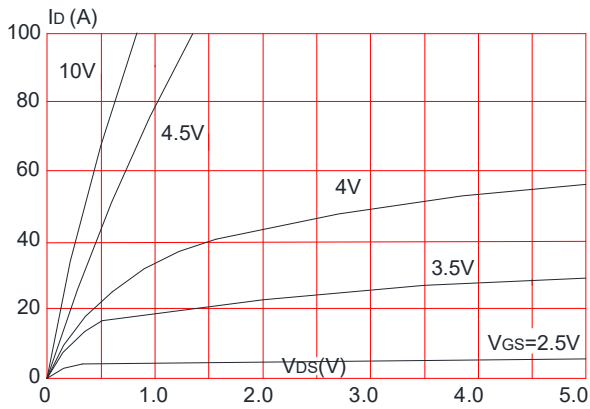

Figure 2: Typical Transfer Characteristics

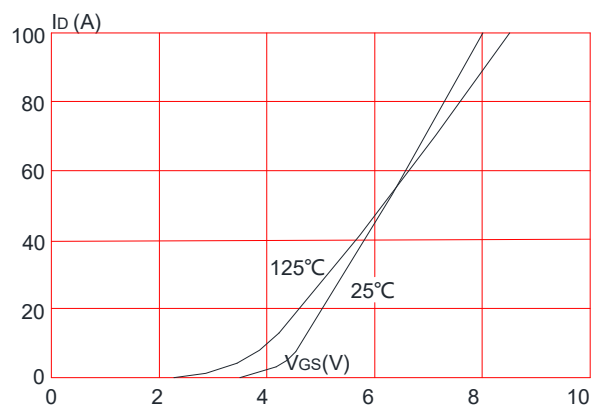

Figure 3: On-resistance vs. Drain Current

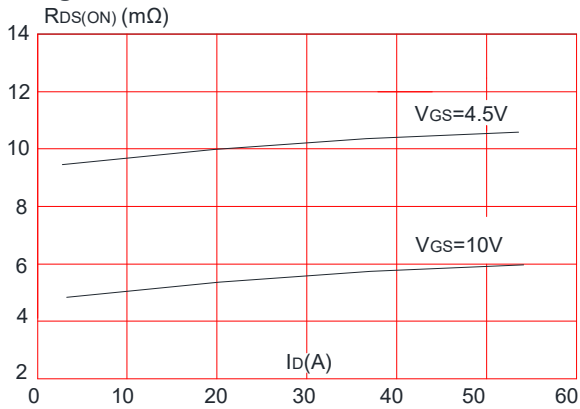

Figure 4: Body Diode Characteristics

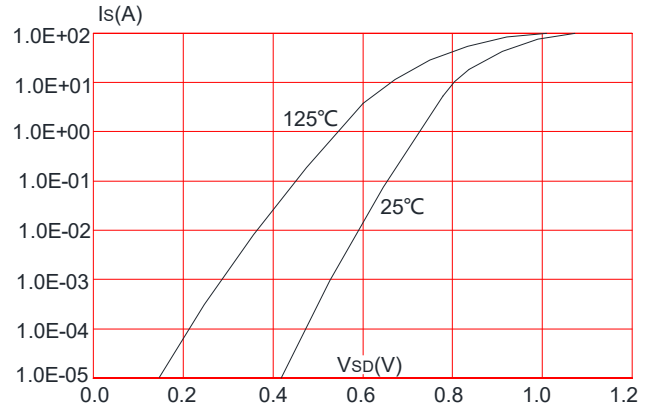

Figure 5: Gate Charge Characteristics

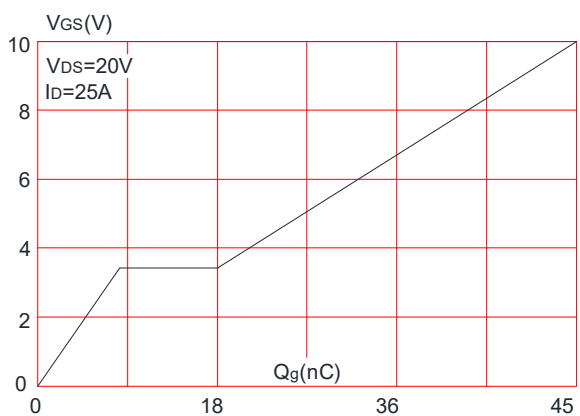

Figure 6: Capacitance Characteristics

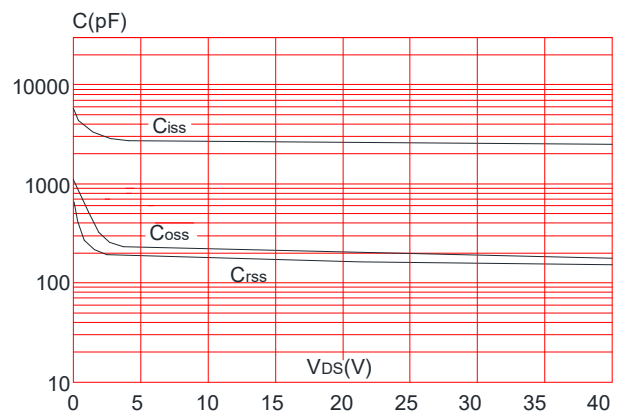



Figure 7: Normalized Breakdown Voltage vs. Junction Temperature

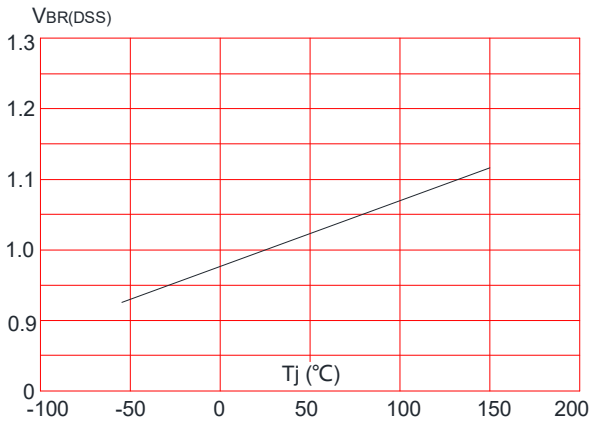

Figure 8: Normalized on Resistance vs. Junction Temperature

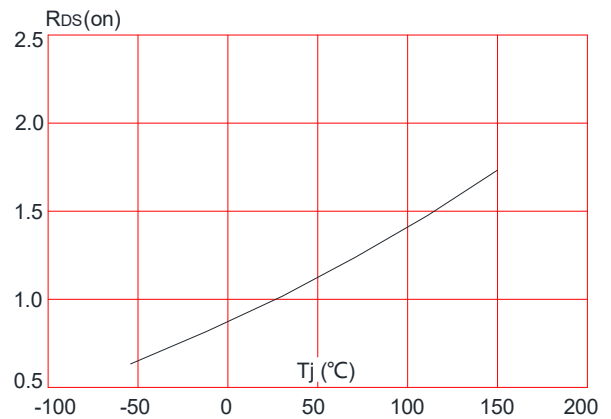

Figure 9: Maximum Safe Operating Area

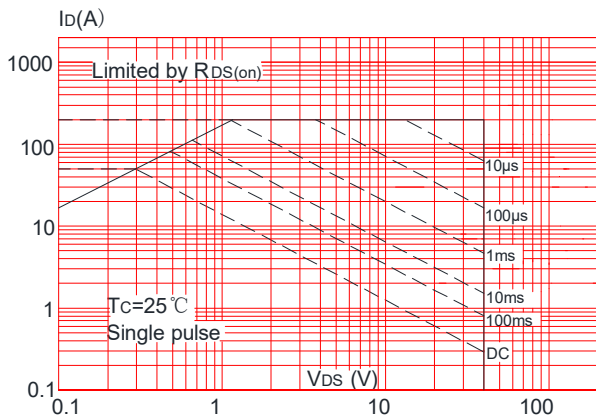

Figure 10: Maximum Continuous Drain Current vs. Case Temperature

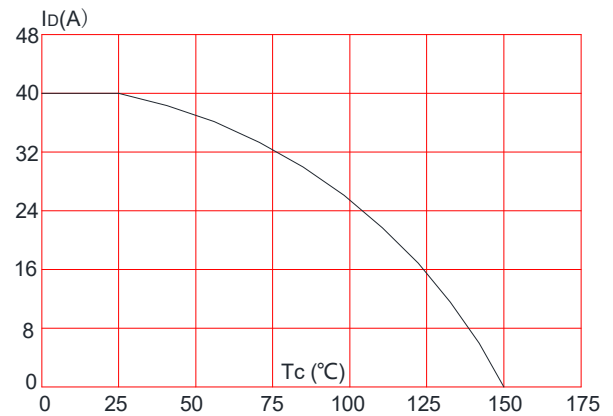
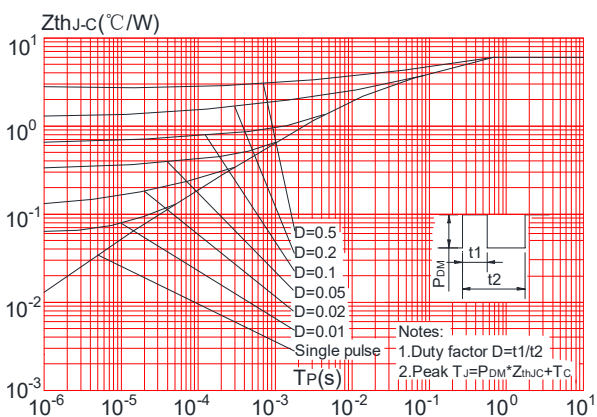

Figure.11: Maximum Effective Transient Thermal Impedance, Junction-to-Case



Test Circuit

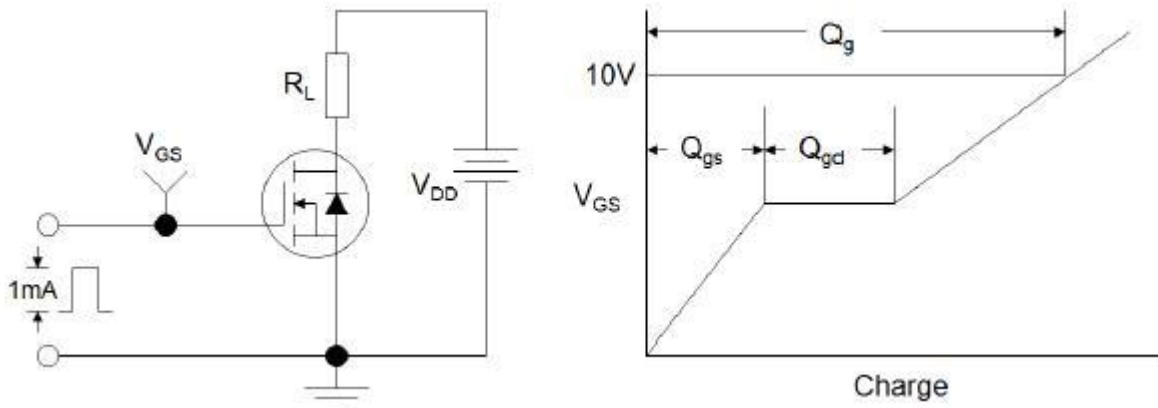

Figure1:Gate Charge Test Circuit & Waveform

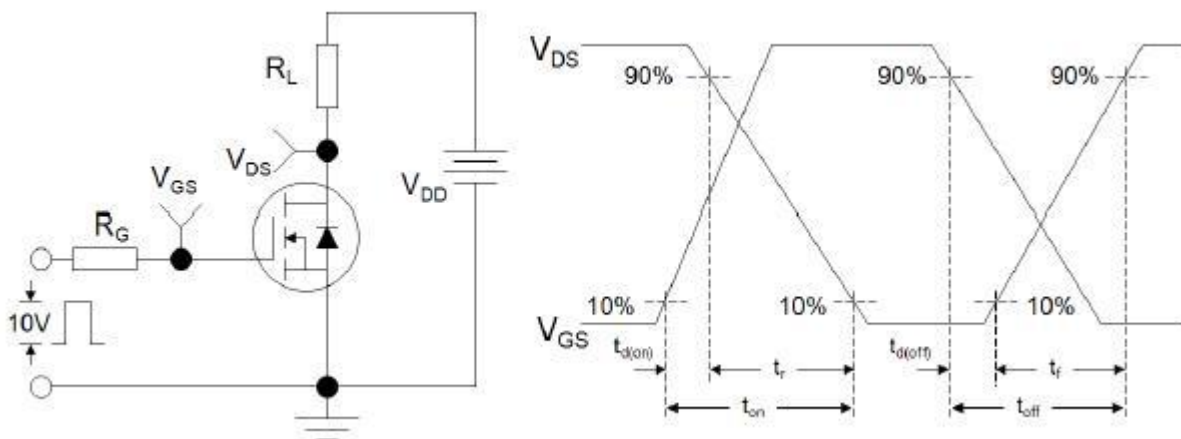

Figure 2: Resistive Switching Test Circuit & Waveforms

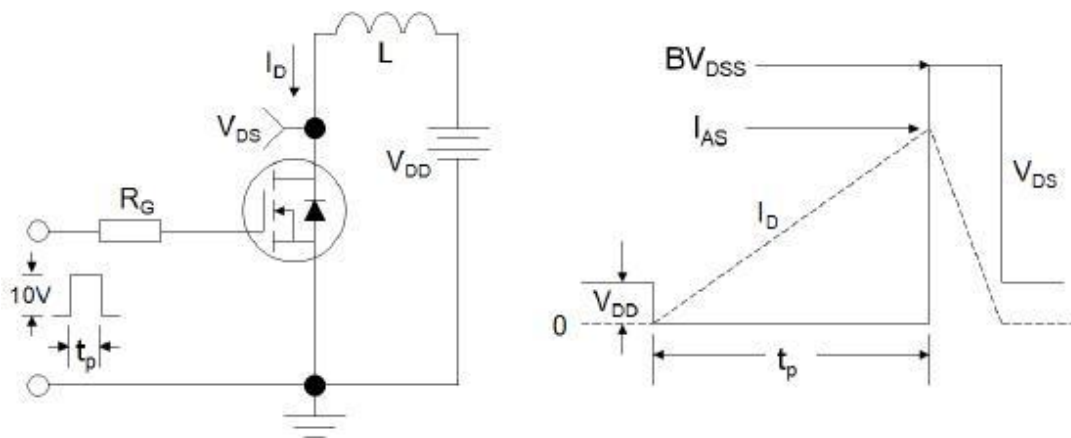
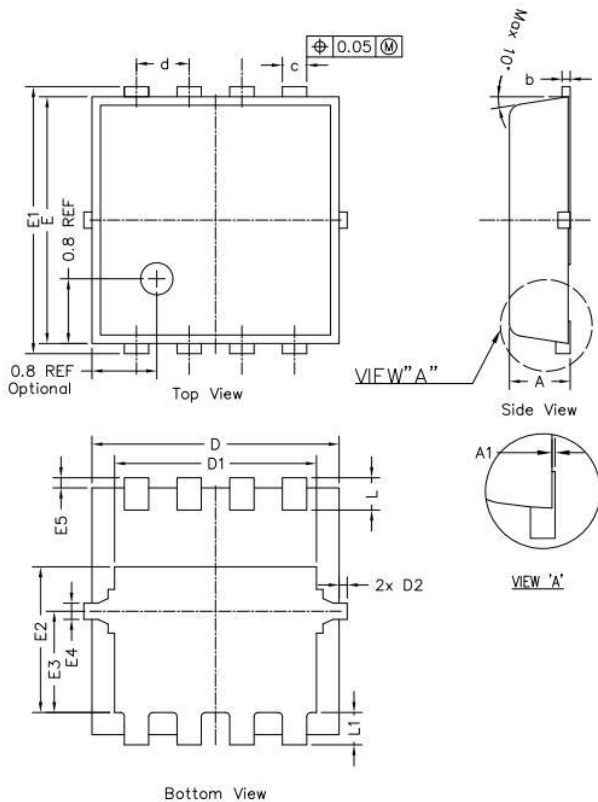

Figure 3:Unclamped Inductive Switching Test Circuit & Waveforms



Package Mechanical Data-PDFN3x3-8L



SYMBOLS	DIMENSION IN MM			DIMENSION IN INCHES		
	MIN	NOM	MAX	MIN	NOM	MAX
A	0.700	0.750	0.800	0.028	0.030	0.031
A1	---	---	0.050	----	----	0.002
b	0.144	0.152	0.202	0.006	0.006	0.008
c	0.250	0.300	0.350	0.010	0.012	0.014
d	0.65 BSC			0.026 BSC		
D	2.950	3.050	3.150	0.116	0.120	0.124
D1	2.390	2.490	2.590	0.094	0.098	0.102
D2	---	---	0.125	---	---	0.005
E	2.950	3.050	3.150	0.116	0.120	0.124
E1	3.200	3.300	3.400	0.126	0.130	0.134
E2	1.700	1.800	1.900	0.067	0.071	0.075
E3	1.150	1.250	1.350	0.045	0.049	0.053
E4	0.150	0.200	0.250	0.006	0.008	0.010
E5	0.075	0.125	0.175	0.003	0.005	0.007
L	0.300	0.400	0.500	0.01	0.02	0.02
L1	0.300	0.400	0.500	0.01	0.02	0.02

Information furnished in this document is believed to be accurate and reliable. However, Jiangsu JieJie Microelectronics Co.,Ltd assumes no responsibility for the consequences of use without consideration for such information nor use beyond it.

Information mentioned in this document is subject to change without notice, apart from that when an agreement is signed, Jiangsu JieJie complies with the agreement.

Products and information provided in this document have no infringement of patents. Jiangsu JieJie assumes no responsibility for any infringement of other rights of third parties which may result from the use of such products and information.



is a registered trademark of Jiangsu JieJie Microelectronics Co.,Ltd.

Copyright ©2022 Jiangsu JieJie Microelectronics Co.,Ltd. Printed All rights reserved.